

# Lovibond® Water Testing

Tintometer® Group



## Photometer-System



### MD 100 • MD 110 • MD 200

**DE** Bedienungsanleitung  
Seite 6–27

**GB** Instruction Manual  
Page 28–49

**FR** Mode d'emploi  
Page 50–71

**IT** Istruzioni d'uso  
Pagina 72–93

**ES** Instrucciones  
Página 94–115

**PT** Instruções de Serviço  
Página 116–137

**NL** Gebruiksaanwijzing  
Blz. 138–159

**CN** 操作手册  
页 160-181

[www.lovibond.com](http://www.lovibond.com)



Konformitätserklärung mit gefordertem Inhalt gemäß EN ISO/IEC 17050-1  
Supplier's declaration of conformity in accordance with EN ISO/IEC 17050-1

**EU-Konformitätserklärung / EU-Declaration of Conformity**

Dokument-Nr. / Monat.Jahr: 4 / 12.2017  
Document No. / Month.Year:

Für das nachfolgend bezeichnete Erzeugnis / For the following mentioned product

Bezeichnung / Name, Modellnummer / Model No.	MD 100 AL 100 , alle Typen - all types
---	--

wird hiermit erklärt, dass es den grundlegenden Anforderungen entspricht, die in den nachfolgend bezeichneten Harmonisierungsrechtsvorschriften festgelegt sind: / It is hereby declared that it complies with the essential requirements which are determined in the following harmonisation rules:

RICHTLINIE 2014/30/EU DES EUROPÄISCHEN PARLAMENTS UND DES RATES vom 26. Februar 2014 zur Harmonisierung der Rechtsvorschriften der Mitgliedstaaten über die elektromagnetische Verträglichkeit (Neufassung)  
DIRECTIVE 2014/30/EU OF THE EUROPEAN PARLIAMENT AND OF THE COUNCIL of 26 February 2014 on the harmonisation of the laws of the Member States relating to electromagnetic compatibility (recast)

RICHTLINIE 2011/65/EU DES EUROPÄISCHEN PARLAMENTS UND DES RATES vom 8. Juni 2011 zur Beschränkung der Verwendung bestimmter gefährlicher Stoffe in Elektro- und Elektronikgeräten (Neufassung)  
DIRECTIVE 2011/65/EU OF THE EUROPEAN PARLIAMENT AND OF THE COUNCIL of 8 June 2011 on the restriction of the use of certain hazardous substances in electrical and electronic equipment (recast)

Angabe der einschlägigen harmonisierten Normen, die zugrunde gelegt wurden, oder Angabe der Spezifikationen, für die die Konformität erklärt wird: / Information of relevant harmonised standards and specifications on which the conformity is based:

Fundstelle / Reference	Ausgabedatum/ Edition	Titel / Title
------------------------	--------------------------	---------------

**Harmonisierte Normen / Harmonised Standards**

DIN EN 61326-1	2013-07	Elektrische Mess-, Steuer-, Regel- und Laborgeräte - EMV-Anforderungen - Teil 1: Allgemeine Anforderungen (IEC 61326-1:2012); Deutsche Fassung EN 61326-1:2013
DIN EN 50581	2013-02	Technische Dokumentation zur Beurteilung von Elektro- und Elektronikgeräten hinsichtlich der Beschränkung gefährlicher Stoffe; Deutsche Fassung EN 50581:2012

Weitere angewandte technische Spezifikationen (z.B. nicht im EU-Amtsblatt veröffentlicht) / Further applied technical specifications (e.g. not published in the Official Journal of the EU)

Diese Erklärung wird verantwortlich für den Hersteller oder seinem Bevollmächtigten / This declaration is made for and on behalf of the manufacturer or his representatives

Name:	Tintometer GmbH
Anschrift / Address:	Schleefstr. 8-12, 44287 Dortmund, Germany

abgegeben durch / declared by

Name, Vorname / First name:	Dr. Grabert, Elmar
Funktion / Function:	Technische Leitung / Director Technology

Bevollmächtigte Person im Sinne des Anhangs II Nr. 1. A. Nr. 2, 2006/42/EG für die Zusammenstellung der technischen Unterlagen / Authorized person for compilation of technical documents on behalf of Annex II No. 1. A. No. 2, 2006/42/EC:

Name:	Corinna Meier
Anschrift / Address:	c/o Tintometer GmbH, Schleefstr. 8-12, 44287 Dortmund

Dortmund, 19.12.2017



Ort, Datum / Place and date of issue

Rechtsgültige Unterschrift / Authorized signature

Diese Erklärung bescheinigt die Übereinstimmung mit den so genannten Harmonisierungsrechtsvorschriften, beinhaltet jedoch keine Zusicherung von Eigenschaften. / This declaration certifies the conformity to the specified directives but contains no assurance of properties.

Zusatzangaben / Additional details:

Diese Erklärung gilt für alle Exemplare, die nach den entsprechenden Fertigungszeichnungen - die Bestandteil der technischen Unterlagen sind - hergestellt werden. Weitere Angaben über die Einhaltung obiger Fundstellen enthält die befugigte Konformitätsaussage unterstützende Begleitdokumentation. / This statement is valid for all copies which were manufactured in accordance with the technical drawings which are part of the technical documentation. More details about compliance of the above mentioned references includes the supporting documentation.

Konformitätserklärung mit gefordertem Inhalt gemäß EN ISO/IEC 17050-1  
Supplier's declaration of conformity in accordance with EN ISO/IEC 17050-1

**EU-Konformitätserklärung / EU-Declaration of Conformity**

Dokument-Nr. / Monat.Jahr: 3 / 9.2016  
Document No. / Month.Year:

Für das nachfolgend bezeichnete Erzeugnis / For the following mentioned product

Bezeichnung / Name, Modellnummer / Model No.	MD 110 AL 110, alle Typen - all types
---	---------------------------------------

wird hiermit erklärt, dass es den grundlegenden Anforderungen entspricht, die in den nachfolgend bezeichneten Harmonisierungsrechtsvorschriften festgelegt sind; / it is hereby declared that it complies with the essential requirements which are determined in the following harmonisation rules:

RICHTLINIE 1999/5/EG DES EUROPÄISCHEN PARLAMENTS UND DES RATES vom 9. März 1999 über Funkanlagen und Telekommunikationsendeinrichtungen und die gegenseitige Anerkennung ihrer Konformität  
DIRECTIVE 1999/5/EC OF THE EUROPEAN PARLIAMENT AND OF THE COUNCIL of 9 March 1999 on radio equipment and telecommunications terminal equipment and the mutual recognition of their conformity

RICHTLINIE 2011/65/EU DES EUROPÄISCHEN PARLAMENTS UND DES RATES vom 8. Juni 2011 zur Beschränkung der Verwendung bestimmter gefährlicher Stoffe in Elektro- und Elektronikgeräten

Angabe der einschlägigen harmonisierten Normen, die zugrunde gelegt wurden, oder Angabe der Spezifikationen, für die die Konformität erklärt wird; / Information of relevant harmonised standards and specifications on which the conformity is based:

Fundstelle / Reference	Ausgabedatum/ Edition	Titel / Title
------------------------	--------------------------	---------------

Harmonisierte Normen / Harmonised Standards

ETSI 301 489 - 1	V1.9.2	Electromagnetic compatibility and Radio spectrum Matters (ERM); ElectroMagnetic Compatibility (EMC) standard for radio equipment and services; Part 1: Common technical requirements
ETSI 301 489 - 17	V2.2.1	Electromagnetic compatibility and Radio spectrum Matters (ERM); ElectroMagnetic Compatibility (EMC) standard for radio equipment; Part 17: Specific conditions for Broadband Data Transmission Systems
ETSI 300 328	V1.9.1	Electromagnetic compatibility and Radio spectrum Matters (ERM); Wideband transmission systems; Data transmission equipment operating in the 2,4 GHz ISM band and using wide band modulation techniques; Harmonized EN covering the essential requirements of article 3.2 of the R&TTE Directive
DIN EN 55022	2011-12	Einrichtungen der Informationstechnik - Funkstöreigenschaften - Grenzwerte und Messverfahren (CISPR 22:2008, modifiziert); Deutsche Fassung EN 55022:2010
DIN EN 61010-1	2011-07	Sicherheitsbestimmungen für elektrische Mess-, Steuer-, Regel- und Laborgeräte - Teil 1: Allgemeine Anforderungen (IEC 61010-1:2010 + Cor. :2011); Deutsche Fassung EN 61010-1:2010
DIN EN 50581	2013-02	Technische Dokumentation zur Beurteilung von Elektro- und Elektronikgeräten hinsichtlich der Beschränkung gefährlicher Stoffe; Deutsche Fassung EN 50581:2012

Weitere angewandte technische Spezifikationen (z.B. nicht im EU-Amtsblatt veröffentlicht) / Further applied technical specifications (e.g. not published in the Official Journal of the EU)

Bluetooth Modul: EN 60950-1	2006+A11:2009+A1:2010+A12:20	Einrichtungen der Informationstechnik - Sicherheit - Teil 1: Allgemeine Anforderungen
Bluetooth Modul: EN 300 328	V1.7.1	Electromagnetic compatibility and Radio spectrum Matters (ERM); Wideband transmission systems; Data transmission equipment operating in the 2,4 GHz ISM band and using wide band modulation techniques; Harmonized EN covering essential requirements under article 3.2 of the R&TTE Directive

Diese Erklärung wird verantwortlich für den Hersteller oder seinem Bevollmächtigten / This declaration is made for and on behalf of the manufacturer or his representatives

Name:	Tintometer GmbH
Anschrift / Address:	Schleefstr. 8-12, 44287 Dortmund, Germany

abgegeben durch / declared by

Name, Vorname / First name:	Dr. Grabert, Elmar
Funktion / Function:	Technische Leitung / Director Technology

Bevollmächtigte Person im Sinne des Anhangs II Nr. 1. A. Nr. 2, 2006/42/EG für die Zusammenstellung der technischen Unterlagen / Authorized person for compilation of technical documents on behalf of Annex II No. 1. A. No. 2, 2006/42/EC:

Name:	Corinna Meier
Anschrift / Address:	c/o Tintometer GmbH, Schleefstr. 8-12, 44287 Dortmund

Dortmund 20.9.2016



Ort, Datum / Place and date of issue

Rechtsgültige Unterschrift / Authorized signature

Diese Erklärung bescheinigt die Übereinstimmung mit den so genannten Harmonisierungsrechtsvorschriften, beinhaltet jedoch keine Zusicherung von Eigenschaften. / This declaration certifies the conformity to the specified directives but contains no assurance of properties.

Zusatzangaben / Additional details:

Diese Erklärung gilt für alle Exemplare, die nach den entsprechenden Fertigungszeichnungen - die Bestandteil der technischen Unterlagen sind - hergestellt werden. Weitere Angaben über die Einhaltung obiger Fundstellen enthält die beifolgende Konformitätsausgabe unterstützende Begleiddokumentation. / This statement is valid for all copies which were manufactured in accordance with the technical drawings which are part of the technical documentation. More details about compliance of the above mentioned references includes the supporting documentation.

**EU-Konformitätserklärung / EU-Declaration of Conformity**

Dokument-Nr. / Monat/Jahr: 5 / 12.2017  
Document No. / Month/Year:

Für das nachfolgend bezeichnete Erzeugnis / For the following mentioned product

Bezeichnung / Name, Modellnummer / Model No.	MD 200 AL 200 , alle Typen - all types
---	--

wird hiermit erklärt, dass es den grundlegenden Anforderungen entspricht, die in den nachfolgend bezeichneten Harmonisierungsrechtsvorschriften festgelegt sind: / It is hereby declared that it complies with the essential requirements which are determined in the following harmonisation rules:

RICHTLINIE 2014/30/EU DES EUROPÄISCHEN PARLAMENTS UND DES RATES vom 26. Februar 2014 zur Harmonisierung der Rechtsvorschriften der Mitgliedstaaten über die elektromagnetische Verträglichkeit (Neufassung)  
DIRECTIVE 2014/30/EU OF THE EUROPEAN PARLIAMENT AND OF THE COUNCIL of 26 February 2014 on the harmonisation of the laws of the Member States relating to electromagnetic compatibility (recast)

RICHTLINIE 2011/65/EU DES EUROPÄISCHEN PARLAMENTS UND DES RATES vom 8. Juni 2011 zur Beschränkung der Verwendung bestimmter gefährlicher Stoffe in Elektro- und Elektronikgeräten (Neufassung)  
DIRECTIVE 2011/65/EU OF THE EUROPEAN PARLIAMENT AND OF THE COUNCIL of 8 June 2011 on the restriction of the use of certain hazardous substances in electrical and electronic equipment (recast)

Angabe der einschlägigen harmonisierten Normen, die zugrunde gelegt wurden, oder Angabe der Spezifikationen, für die die Konformität erklärt wird: / Information of relevant harmonised standards and specifications on which the conformity is based:

Fundstelle / Reference	Ausgabedatum/ Edition	Titel / Title
------------------------	--------------------------	---------------

Harmonisierte Normen / Harmonised Standards

DIN EN 61326-1	2013-07	Elektrische Mess-, Steuer-, Regel- und Laborgeräte - EMV-Anforderungen - Teil 1: Allgemeine Anforderungen (IEC 61326-1:2012); Deutsche Fassung EN 61326-1:2013
DIN EN 50581	2013-02	Technische Dokumentation zur Beurteilung von Elektro- und Elektronikgeräten hinsichtlich der Beschränkung gefährlicher Stoffe; Deutsche Fassung EN 50581:2012

Weitere angewandte technische Spezifikationen (z.B. nicht im EU-Amtsblatt veröffentlicht) / Further applied technical specifications (e.g. not published in the Official Journal of the EU)

Diese Erklärung wird verantwortlich für den Hersteller oder seinem Bevollmächtigten / This declaration is made for and on behalf of the manufacturer or his representatives

Name:	Tintometer GmbH
Anschrift / Address:	Schleefstr. 8-12, 44287 Dortmund, Germany

abgegeben durch / declared by

Name, Vorname / First name:	Dr. Grabert, Elmar
Funktion / Function:	Technische Leitung / Director Technology

Bevollmächtigte Person im Sinne des Anhangs II Nr. 1. A. Nr. 2, 2006/42/EG für die Zusammenstellung der technischen Unterlagen / Authorized person for compilation of technical documents on behalf of Annex II No. 1. A. No. 2, 2006/42/EC:

Name:	Corinna Meier
Anschrift / Address:	c/o Tintometer GmbH, Schleefstr. 8-12, 44287 Dortmund

Dortmund, 19.12.2017



Ort, Datum / Place and date of issue

Rechtsgültige Unterschrift / Authorized signature

Diese Erklärung bescheinigt die Übereinstimmung mit den so genannten Harmonisierungsrechtsvorschriften, beinhaltet jedoch keine Zusicherung von Eigenschaften. / This declaration certifies the conformity to the specified directives but contains no assurance of properties.

Zusatzangaben / Additional details:

Diese Erklärung gilt für alle Exemplare, die nach den entsprechenden Fertigungszeichnungen - die Bestandteil der technischen Unterlagen sind - hergestellt werden. Weitere Angaben über die Einhaltung obiger Fundstellen enthält die beigefügte Konformitätsausgabe unterstützende Begleitdokumentation. / This statement is valid for all copies which were manufactured in accordance with the technical drawings which are part of the technical documentation. More details about compliance of the above mentioned references includes the supporting documentation.

• <b>Wichtige Informationen</b> .....	7
• <b>Allgemeine Hinweise</b> .....	8
Hinweise zur Arbeitstechnik .....	8
Hinweise zu den Methoden .....	8
Aufsetzen des Dichtrings .....	9
Aufsetzen der Abdeckkappe .....	9
Positionierung des Adapters .....	9
Positionierung der Küvetten .....	9
Richtiges Befüllen der Küvette .....	9
Richtige Handhabung der Reagenzien .....	9
Batteriewechsel .....	10
• <b>Funktionsbeschreibung</b> .....	11
Inbetriebnahme .....	11
Scroll Memory (SM) .....	11
Nullabgleich durchführen .....	11
OTZ (One Time Zero) .....	12
Ablauf einer Messung .....	12
Hintergrundbeleuchtung der Anzeige .....	12
Countdown / Reaktionszeit .....	13
Auslesen von gespeicherten Daten .....	13
• <b>Menü-Optionen</b> .....	14
Menü-Aufrufen .....	14
Menü-Wahl .....	14
Auslesen von gespeicherten Daten .....	14
Übertragen von gespeicherten Daten - an einen Drucker oder PC - beim MD 100 und MD 200 .....	15
Übertragen von gespeicherten Daten - Bluetooth® - beim MD 110 .....	16
Einstellen von Datum und Zeit .....	17
• <b>Anwenderjustierung</b> .....	18
Anzeige der aktuellen Justierungseinstellung .....	18
Anwenderjustierung .....	18
Justiermodus Fluorid .....	20
Rückkehr zur Fabrikationsjustierung .....	21
• <b>Überprüfung des Gerätes</b> .....	22
Verwendung eines Referenzstandard-Kits .....	22
Verwendung eines Verifikationsstandard-Kits .....	23
• <b>Technische Daten</b> .....	25
• <b>Fehlermeldungen</b> .....	27
• <b>Bedienerhinweise</b> .....	27

## Wichtige Information für Verbraucher in der EU

### Entsorgungshinweis zu Batterien und Akkus



Jeder Verbraucher ist aufgrund der Batterieverordnung (Richtlinie 2006/66/EG) gesetzlich zur Rückgabe aller ge- und verbrauchten Batterien bzw. Akkus verpflichtet. Die Entsorgung über den Hausmüll ist verboten. Da auch bei Produkten aus unserem Sortiment Batterien und Akkus im Lieferumfang enthalten sind, weisen wir Sie auf folgendes hin: Verbrauchte Batterien und Akkus gehören nicht in den Hausmüll, sondern können unentgeltlich bei den öffentlichen Sammelstellen Ihrer Gemeinde und überall dort abgegeben werden, wo Batterien und Akkus der betreffenden Art verkauft werden. Weiterhin besteht für den Endverbraucher die Möglichkeit, Batterien und Akkus an den Händler, bei dem sie erworben wurden, zurückzugeben (gesetzliche Rücknahmepflicht).

### Entsorgung von elektronischen Geräten



Aufgrund der Europäischen Verordnung 2012/19/EU darf Ihr elektronisches Gerät nicht mit dem normalen Hausmüll entsorgt werden! Wir entsorgen Ihr elektrisches Gerät auf eine professionelle und für die Umwelt verantwortungsvolle Weise. Dieser Service ist, die Transportkosten nicht inbegriffen, kostenlos. Dieser Service gilt ausschließlich für elektrische Geräte die nach dem 13.08.2005 erworben wurden. Senden Sie Ihr zu entsorgendes Tintometer Gerät frei Haus an Ihren Lieferanten.

## Sicherheit - Allgemeine Hinweise

Die Haftung und Gewährleistung des Herstellers für Schäden und Folgeschäden erlischt bei bestimmungswidriger Verwendung, Nichtbeachten dieser Betriebsanleitung, Einsatz ungenügend qualifizierten Fachpersonals sowie eigenmächtiger Veränderung am Gerät. Der Hersteller haftet nicht für Kosten oder Schäden, die dem Benutzer oder Dritten durch den Einsatz dieses Geräts, vor allem bei unsachgemäßem Gebrauch des Geräts oder bei Missbrauch oder Störungen des Anschlusses oder des Geräts, entstehen. Der Hersteller übernimmt keine Haftung bei Druckfehlern.

## Sicherheitsinformationen in der Bedienungsanleitung

Diese Bedienungsanleitung enthält wichtige Informationen für den sicheren Betrieb des Produkts. Lesen Sie diese Bedienungsanleitung vollständig durch und machen Sie sich mit dem Produkt vertraut, bevor sie es in Betrieb nehmen oder damit arbeiten. Halten Sie die Bedienungsanleitung immer griffbereit, um bei Bedarf darin nachschlagen zu können.



### Hinweis:

Die Beschreibung der Methoden und die Handhabung der Reagenzien sind nicht Bestandteil dieser Anleitung. Sie befinden sich auf dem beiliegenden Datenträger oder können von unserer Webseite heruntergeladen werden.

## Hinweise zur Arbeitstechnik

1. Küvetten, Deckel und Rührstab müssen **nach jeder Analyse** gründlich gereinigt werden, um Verschleppungsfehler zu verhindern. Schon geringe Rückstände an Reagenzien führen zu Fehlmessungen.
2. Die Außenwände der Küvetten müssen sauber und trocken sein, bevor die Analyse durchgeführt wird. Fingerabdrücke oder Wassertropfen auf den Lichtdurchtrittsflächen der Küvetten führen zu Fehlmessungen.
3. Nullabgleich und Test müssen mit derselben Küvette durchgeführt werden, da die Küvetten untereinander geringe Toleranzen aufweisen können.
4. Die Küvette muss für den Nullabgleich und den Test immer so in den Messschacht gestellt werden, dass die Graduierung mit dem weißen Dreieck zur Gehäusemarkierung zeigt.
5. Nullabgleich und Test müssen mit geschlossenem Küvettendeckel erfolgen. Der Küvettendeckel muss mit einem Dichtring versehen sein.
6. Bläschenbildung an den Innenwänden der Küvette führt zu Fehlmessungen. In diesem Fall wird die Küvette mit dem Küvettendeckel verschlossen und die Bläschen durch Umschwenken gelöst, bevor der Test durchgeführt wird.
7. Das Eindringen von Wasser in den Messschacht muss vermieden werden, weil dies zu fehlerhaften Messergebnissen führen kann.
8. Verschmutzungen im transparenten Messschacht führen zu Fehlmessungen. Die Lichtdurchtrittsflächen des transparenten Messschachtes sind in regelmäßigen Abständen zu überprüfen und ggf. zu reinigen. Für die Reinigung eignen sich fusselfreie, angefeuchtete Tücher (ölfrei) und Wattestäbchen.
9. Größere Temperaturunterschiede zwischen Photometer und Umgebung können zu Fehlmessungen führen, z.B. durch die Bildung von Kondenswasser im Messschacht und an der Küvette.
10. Das Gerät bei Betrieb vor direkter Sonneneinstrahlung schützen.
11. Die Reagenztabletten müssen direkt aus der Folie in die Wasserprobe gegeben werden, ohne sie mit den Fingern zu berühren.
12. Die Reihenfolge der Reagenzienzugabe ist unbedingt einzuhalten.

## Hinweise zu den Methoden

- Anwendungsmöglichkeiten, Analysenvorschrift und Matrixeffekte der Methoden beachten.
- Verschiedene Nachfüllpackungen auf Anfrage erhältlich.
- Reagenzien sind für die chemische Analyse bestimmt und dürfen nicht in die Hände von Kindern gelangen.
- Reagenzlösungen ordnungsgemäß entsorgen.
- Sicherheitsdatenblätter bei Bedarf anfordern.  
(Internet: [www.lovibond.com](http://www.lovibond.com))



**Aufsetzen des Dichtrings:**

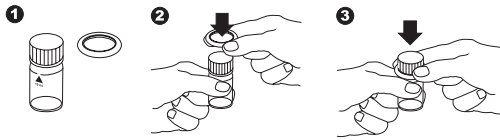

**Aufsetzen der Abdeckkappe:**

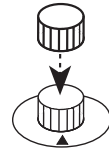

**Positionierung des Adapters:**

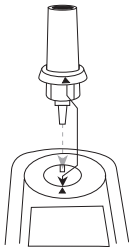

**Positionierung der Küvetten:**

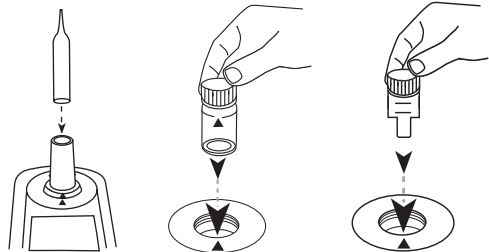

**Richtiges Befüllen der Küvette:**

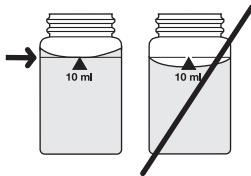

**Richtige Handhabung der Reagenzien:**

**Powder Packs**

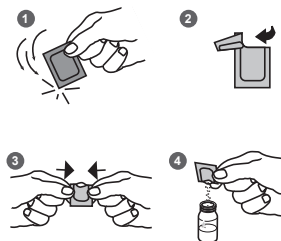

**Flüssigreagenzien**



**Blistertabletten**

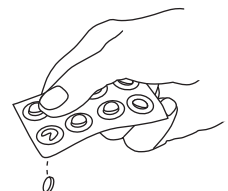

**Batteriewechsel:**

**MD 100 / MD 110**

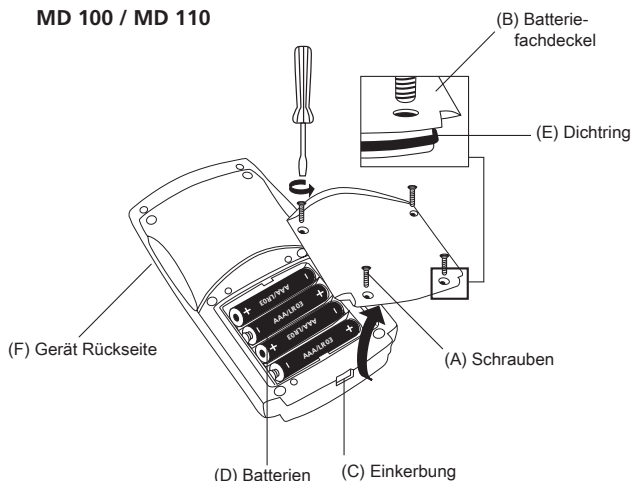

**MD 200**

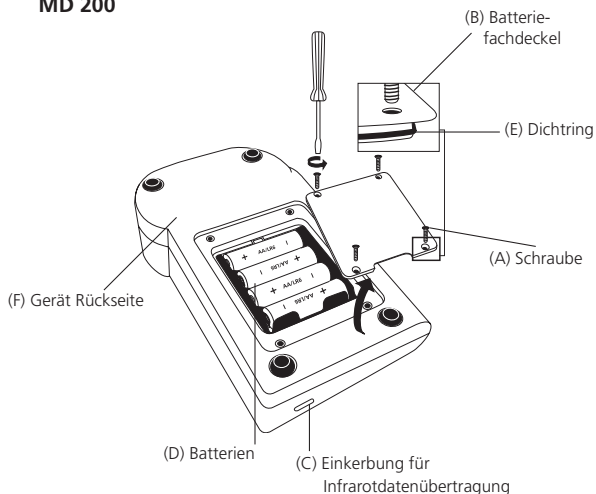

**ACHTUNG:**

**Um eine vollständige Dichtigkeit des Photometers gewährleisten zu können, muss der Dichtring (E) eingelegt und der Batteriefachdeckel (B) verschraubt sein.**

Wenn die Batterien für mehr als 1 Minute aus dem Gerät entfernt werden, erscheint bei erneuter Spannungsversorgung (Einlegen der neuen Batterien) automatisch das Datum-Uhrzeit-Programm beim Einschalten des Gerätes.

## Inbetriebnahme



Gerät einschalten



Methode auswählen



### Scroll Memory (SM)

Bei Multiparameter-Geräten ist die Reihenfolge der verschiedenen Methoden festgelegt. Nach dem Einschalten des Gerätes wird automatisch die Methode angezeigt, die zuletzt vor Ausschalten des Gerätes gewählt worden war. Dadurch wird ein schnellerer Zugriff auf favorisierte Methoden ermöglicht.



### Hinweis:

Die Beschreibung der Methoden und die Handhabung der Reagenzien sind nicht Bestandteil dieser Anleitung, sondern sind in einem separaten Dokument enthalten.



### Fluoridmethode

#### Achtung!

Vor der ersten Inbetriebnahme muss eine Justierung der Methode durchgeführt werden (siehe: ▽ Justiermodus Fluorid). Für Justierung und Probenmessung muss derselbe Batch SPADNS Reagenzlösung verwendet werden. Die Justierung des Gerätes ist für jeden neuen Batch SPADNS Reagenzlösung durchzuführen.



### Nullabgleich durchführen

24-mm-Küvette mit 10 ml Probe füllen

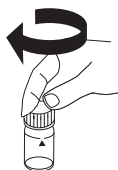

Küvette verschließen



Probenküvette in den Messschacht stellen  
Positionierung beachten

## DE Funktionsbeschreibung



Taste [ZERO/TEST] drücken

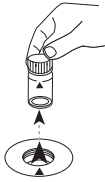

Küvette aus dem Messschacht nehmen

### OTZ (One Time Zero)

Der One Time Zero ist für alle Photometervarianten verfügbar, bei denen der Nullabgleich in einer 24-mm-Rundküvette mit Probenwasser erfolgt. Er kann verwendet werden, wenn unterschiedliche Tests unter identischen Testbedingungen mit derselben Wasserprobe durchgeführt werden. Bei einem Methodenwechsel ist es dann nicht mehr notwendig einen neuen Nullabgleich durchzuführen; es kann direkt mit dem Test begonnen werden. Der Nullabgleich wird bis zum Ausschalten des Gerätes gespeichert.

Ein neuer Nullabgleich kann bei Bedarf jederzeit vorgenommen werden.



One Time Zero (OTZ), 1x Nullabgleich durchführen, danach Messung der Parameter



Neuer Nullabgleich, Taste für 2 Sekunden drücken

### Ablauf einer Messung



Reagenz (z.B. eine Reagenztablette) zugeben (siehe Methodenbeschreibung)

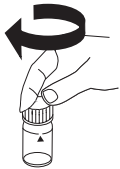

Küvette verschließen



Probenküvette in den Messschacht stellen  
Positionierung beachten



Taste [ZERO/TEST] drücken



### Hintergrundbeleuchtung der Anzeige

drücken, während der Messung erfolgt automatische Abschaltung

### Countdown / Reaktionszeit

Bei Methoden mit Reaktionszeit kann bei einigen Methoden, während der Testdurchführung, eine Count-Down-Funktion zugeschaltet werden.



drücken und **gedrückt** halten



drücken



loslassen

Countdown / Reaktionszeit läuft, Messung erfolgt nach Ablauf der Zeit automatisch.



Countdown / Reaktionszeit abbrechen



**Achtung:**

**Nicht eingehaltene Reaktionszeiten können zu fehlerhaften Messergebnissen führen.**

**Hinweis:**

Die Beschreibung der Methoden und die Handhabung der Reagenzien sind nicht Bestandteil dieser Anleitung, sondern sind in einem separaten Dokument enthalten.



### Auslesen von gespeicherten Daten

Das Gerät verfügt über einen Ringspeicher. Die letzten 16 Messwerte sind abrufbar.



Gerät einschalten



länger als 4 Sekunden gedrückt halten, dann loslassen, um direkt in das Speichermenü zu gelangen



durch Datensätze scrollen



Wiederholung des Datensatzes



Rückkehr in den Messmodus

Anzeige in folgendem Format (Zeile für Zeile in automatischer Abfolge, 3 Sekunden pro Zeile, bis zur Anzeige des Ergebnisses):

lfd. Nummer	n xx (xx: 16...1)
Jahr	YYYY (z.B. 2014)
Datum	MM.dd (MonatMonat.TagTag)
Zeit	hh:mm (StundeStunde:MinuteMinute)
Methode	Methodensymbol
Ergebnis	x,xx

## Menü-Aufrufen

Gerät ist ausgeschaltet



drücken und **gedrückt** halten



kurz drücken, loslassen



loslassen

## Menü-Wahl

drücken, um Menüpunkt auszuwählen ("scrollen")



Auswahl der folgenden Menüpunkte:

diS Auslesen gespeicherter Daten

Prt Drucken gespeicherter Daten

Einstellung von Datum und Uhrzeit

Anwenderjustierung

Der ausgewählte Menüpunkt wird durch einen Pfeil im Display angezeigt.



oder



je nach

Gerätevariante

## diS – Auslesen von gespeicherten Daten

Menü aufrufen (siehe "Menü-Aufrufen")

durch Datensätze scrollen

Wiederholung des Datensatzes

Rückkehr in den Messmodus

Das Gerät verfügt über einen Ringspeicher. Die letzten 16 Messwerte sind abrufbar.

Anzeige in folgendem Format (Zeile für Zeile in automatischer Abfolge, 3 Sekunden pro Zeile, bis zur Anzeige des Ergebnisses):

Ifd. Nummer	n xx (xx: 16...1)
Jahr	YYYY (z.B. 2014)
Datum	MM.dd (MonatMonat.TagTag)
Zeit	hh:mm (StundeStunde:MinuteMinute)
Methode	Methodensymbol
Ergebnis	x,xx



Store Date  
▲ Prt  
Time Cal

## ▲ Prt – Übertragen von gespeicherten Daten - an einen Drucker oder PC - beim MD 100 und MD 200



**ACHTUNG:** Zur Übertragung der gespeicherten Daten an einen Drucker oder PC wird ein optional erhältliches Infrarotdatenübertragungsmodul (IRiM) benötigt. Dies kann in Kombination mit den Geräten MD 100 und MD 200 verwendet werden.

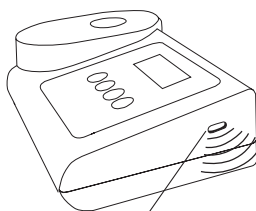
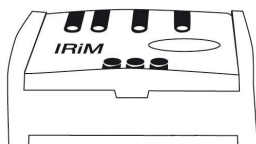

Einkerbung für  
Infrarotdatenübertragung



Menü aufrufen (siehe "Menü-Aufrufen")



drücken

**PrtG**

Das IRiM und die Peripheriegeräte müssen betriebsbereit sein. Das Gerät zeigt für ca. 1 Sekunde „PrtG“ (Printing).

**Mode**

drücken

Im Anschluss wird die Nummer des ersten Datensatzes angezeigt und die Daten übertragen. Nacheinander werden sämtliche gespeicherten Datensätze übertragen. Nach Beendigung schaltet das Gerät in den Messmodus.

**On  
Off**

Der Druckvorgang kann durch Drücken der Taste [On/Off] abgebrochen werden. Das Gerät schaltet sich aus.



**E 162**

Wenn keine Kommunikation mit einem IRiM möglich ist, tritt nach ca. 2 Minuten ein Time-out auf. Es wird für ca. 4 Sekunden die Fehlernummer **E 162** angezeigt, dann geht das Gerät in den normalen Messmodus zurück (siehe auch IRiM-Anleitung).



## ▲ Prt – Übertragen von gespeicherten Daten - Bluetooth® - beim MD 110

Das MD 110 verfügt über eine Bluetooth® 4.0 Schnittstelle, welche eine kabellose Übertragung von Messergebnissen ermöglicht. Hierbei können gespeicherte Ergebnisse übertragen werden. Bluetooth® 4.0 ist auch bekannt als Bluetooth® Smart oder Bluetooth® LE (Low energy). Die Daten werden vom Photometer im .csv-Format übertragen. Eine Definition der vom Photometer übertragenden Information kann unter [www.lovibond.com](http://www.lovibond.com) heruntergeladen werden. Zum Empfang der Daten stellt die Tintometer GmbH diverse Lösungen bereit.

Für mobile Endgeräte steht die App AqualX® zur Verfügung, welche die empfangenen Daten verwaltet und graphisch auswertet. Sowohl die Daten als auch die Graphiken können direkt per E-Mail weitergeleitet werden. AqualX® kann für iOS® im iTunes Store® und für Android™ im Google Play™ Store kostenfrei heruntergeladen werden.

Ein Softwaretool ermöglicht den Empfang der auf dem Photometer gespeicherten Daten auf einem PC. Die Daten können in ein Excel®-Sheet exportiert werden, welches direkt als Auswertetool in der für den Anwender gewohnten Weise genutzt werden kann. Sollte kein Excel® vorhanden sein, können die Daten alternativ als .txt Datei gespeichert werden und stehen somit für eine spätere Auswertung bereit. Zum Empfang der Daten wird der im Lieferumfang der Software enthaltene Bluetooth® Dongle benötigt.

Artikel	Artikel-Nr.
Software, inkl. Bluetooth® Dongle	2444480

Menü aufrufen (siehe "Menü-Aufrufen")

drücken

drücken

Die Peripheriegeräte müssen betriebsbereit sein.

Das Gerät zeigt den Status der Bluetooth® Verbindung an.

In der Anzeige erscheint: „ncon“ (not connecting).

Es ist ggf. eine Aktualisierung der Liste der erkannten Geräte in der Software auf dem Peripheriegerät notwendig, siehe dazu Anleitung der AqualX oder der Datenübertragungs-Software für den Bluetooth®-Dongle.

In der Anzeige erscheint: „con“ (connecting).

Durch Drücken der [MODE]-Taste wird die Übertragung gestartet; das Gerät zeigt während der Datenübertragung und des Verbindungsaufbaus „PrtG“ (Printing).

Nacheinander werden sämtliche gespeicherten Datensätze übertragen.







Die Messergebnisse bleiben auf dem Photometer gespeichert.

Nach Beendigung schaltet das Gerät in den Messmodus und die Bluetooth® Verbindung wird unterbrochen.

Die Übertragung kann jederzeit durch Drücken der Taste [On/Off] abgebrochen werden. Das Gerät schaltet sich aus.



### Einstellen von Datum und Zeit (24-h-Format)

Menü aufrufen (siehe "Menü-Aufrufen")



2x drücken = Pfeilsymbole auf Time & Date



bestätigen



Wert erhöhen



Wert verringern



jeweilige Einstellung bestätigen



Im Display erscheint "IS SET" nach der letzten Bestätigung.

Das Gerät kehrt automatisch in den Messmodus zurück.

### Anzeige aktuelle Justiereinstellung

Menü aufrufen (siehe "Menü-Aufrufen")

3x = Pfeilsymbole auf Cal bzw. Cal im Display

bestätigen

Abwechselnd erscheint im Display: CAL/„Methode“.



#### Erläuterung:

Anwenderjustierung

Fabrikationsjustierung



### 4 Anwenderjustierung

Menü aufrufen (siehe "Menü-Aufrufen")

3x = Pfeilsymbole auf Cal bzw. Cal im Display

bestätigen

Abwechselnd erscheint im Display: CAL/„Methode“.



Methode auswählen



24-mm-Küvette mit 10 ml Probe füllen

Die Probe sollte aus farb- und trübungsfreiem Wasser (z.B. VE-Wasser, reines Trinkwasser) bestehen.

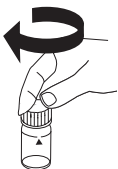

Küvette verschließen

## DE Anwenderjustierung



Küvette in den Messschacht stellen  
Positionierung beachten



drücken



blinkt ca. 8 Sekunden

0.0.0

CAL

Die Bestätigung des Nullabgleichs 0.0.0 erscheint im Wechsel mit CAL.



Die Messung mit einem Standard bekannter Konzentration durchführen.

drücken



blinkt für ca. 3 Sekunden

ERGEBNIS

CAL

Das Ergebnis erscheint im Wechsel mit CAL.

Wenn das Ergebnis mit dem Wert des verwendeten Standards übereinstimmt (innerhalb der zu berücksichtigenden Toleranz), Justiermodus verlassen.



drücken



Wenn das Ergebnis außerhalb des Wertes liegt (unter Berücksichtigung der Toleranz), angezeigten Wert ändern:

1 x Drücken erhöht das angezeigte Ergebnis um 1 Digit.



1 x Drücken verringert das angezeigte Ergebnis um 1 Digit.

Tasten wiederholt drücken bis das angezeigte Ergebnis mit dem Wert des verwendeten Standards übereinstimmt.

CAL

ERGEBNIS + x

Das Ergebnis erscheint im Wechsel mit CAL



länger als 4 Sekunden gedrückt halten

Die Anwenderjustierung ist abgeschlossen und gespeichert.

## 4 Justiermodus Fluorid

### Justierung erfolgt mit:

0 mg/l und 1 mg/l F Standard und einer sauberen Küvette  
(siehe Methodenbeschreibung, Anm.)

### Justierung Fluorid:

Menü aufrufen (siehe "Menü-Aufrufen")



3x = Pfeilsymbole auf Cal bzw. Cal im Display



bestätigen



CAL

Nach Bestätigen der Auswahl durch die Taste [MODE] erscheint abwechselnd im Display: CAL/F.



F

In eine saubere Küvette 10 ml VE-Wasser geben und mit dem Küvetten-  
deckel verschließen.



Die Küvette in den Messschacht stellen. Positionierung  $\bar{X}$ .



F

Taste [ZERO/TEST] drücken.

Das Methodensymbol blinkt ca. 8 Sekunden.



0.0.0

Die Bestätigung des Nullabgleichs 0.0.0 erscheint im Wechsel mit CAL.



CAL

In die 10-ml-VE-Wasser **exakt 2 ml SPADNS-Reagenzlösung** geben.  
Die Küvette mit dem Küvetten-  
deckel fest verschließen und den Inhalt  
durch Umschwenken mischen.



Die Küvette in den Messschacht stellen. Positionierung  $\bar{X}$ .



F

Taste [ZERO/TEST] drücken.

Das Methodensymbol blinkt für ca. 3 Sekunden.



FO

In der Anzeige erscheint:

Die Küvette aus dem Messschacht nehmen, Küvette und Küvetten-  
deckel gründlich reinigen und mit **exakt 10 ml Fluorid Standard**  
**(Konzentration 1 mg/l F)** füllen.

In die 10 ml Fluorid Standard **exakt 2 ml SPADNS Reagenzlösung**  
geben. Die Küvette mit dem Küvetten-  
deckel verschließen und den  
Inhalt durch Umschwenken mischen.



Die Küvette in den Messschacht stellen. Positionierung  $\bar{X}$ .



F

Taste [ZERO/TEST] drücken.

Das Methodensymbol blinkt für ca. 3 Sekunden.

## DE Anwenderjustierung

F1



: :

In der Anzeige erscheint:

Durch Drücken der Taste [ON/OFF] wird die neue Justierung abgespeichert.

Im Display erscheint für 3 Sekunden die Bestätigung der Justierung.

### Rückkehr zur Fabrikationsjustierung

Die Rückkehr von der Anwenderjustierung zur Fabrikationsjustierung ist nur gemeinsam für alle Methoden möglich.

Bei einer Methode, die durch den Anwender justiert wurde, wird bei Anzeige des Ergebnisses im Display ein Pfeil in der Position Cal bzw. Cal im Display angezeigt.

Um das Gerät in die Fabrikationsjustierung zurückzusetzen, wird wie folgt vorgegangen:



SEL

CAL

drücken und **gemeinsam gedrückt halten**

kurz drücken, loslassen

nach ca. 1 Sekunde Tasten loslassen

In der Anzeige erscheint abwechselnd:

Fabrikationsjustierung

**oder:**

Anwenderjustierung

SEL

cAL



SEL

CAL



Durch Drücken die Fabrikationsjustierung für alle Methoden gleichzeitig aktivieren.

In der Anzeige erscheint abwechselnd:

Das Gerät ausschalten

## DE Überprüfung des Gerätes



### Verwendung eines Referenzstandard-Kits (siehe auch Seite 19 Referenzstandard-Kits für MD 100, MD 110 und MD 200)

Gemäß der Betriebsanleitung die entsprechende Methode unter Berücksichtigung des verwendeten Reagenzsystems (Tablette, Flüssigreagenz oder Powder Pack) auswählen.

Bei Verwendung von Flüssigreagenzien ist die Tablettenmethode zu wählen.



Gerät einschalten.



Methode auswählen.

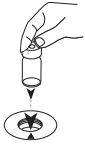

Referenz-Standard „Zero“ Küvette in den Messschacht stellen. Positionierung beachten.

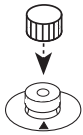

Abdeckkappe aufsetzen.



Die Taste [ZERO/TEST] drücken.

**0.0.0**

Bestätigung des Nullabgleichs

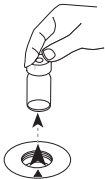

Küvette aus dem Messschacht nehmen.

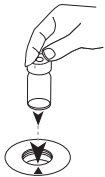

Referenz-Standard für die entsprechende Methode in den Messschacht stellen. Positionierung beachten.



Die Taste [ZERO/TEST] drücken.

**ERGEBNIS**

Das Ergebnis wird mit dem auf dem Test-Zertifikat dokumentierten Wert, unter Berücksichtigung der Toleranzen (Standard & Gerät),



verglichen. Die richtige Zuordnung zu den gewählten Reagenzsystemen beachten!

Falls das Ergebnis außerhalb der Toleranz liegt, ist die Haltbarkeit der Standards zu prüfen und ob das Photometer in der Werksjustierung ist. Sollte dies zutreffen, empfiehlt sich eine Rücksendung des Gerätes an den Hersteller bzw. Händler.

## Referenzstandard-Kits für MD 100, MD 110 und MD 200

Die Referenz-Standards werden ausschließlich dazu benutzt, die Messgenauigkeit für die im Test-Zertifikat gelisteten Photometer zu überprüfen. Die Kalibrierung (Justierung) dieser Geräte ist unter normalen Arbeitsbedingungen langzeitstabil. Das Photometer kann nicht mit den Referenzstandards justiert werden.

Die Referenz-Standards werden in fest verschlossenen Küvetten geliefert.

Die Sollwerte für jeden Standard sind im Zertifikat dokumentiert. Die Haltbarkeit der Referenzstandards beläuft sich auf zwei Jahre ab Herstellungsdatum bei sachgerechtem Gebrauch und sachgerechter Lagerung. Küvetten von außen immer mit einem sauberen Tuch reinigen, bevor sie verwendet werden.

Bestell-Nr.	Artikel	Messbereich
275650	<b>Kit Chlor</b> für Geräte mit Tabletten- / Flüssigreagenzien	0,2* + 1,0* mg/l
275655	<b>Kit Chlor</b> für Geräte mit Tabletten- / Flüssigreagenzien	0,5* + 2,0* mg/l
275656	<b>Kit Chlor</b> für Geräte mit Tabletten- / Flüssigreagenzien	1,0* + 4,0* mg/l
275660	<b>Kit Chlor</b> für Geräte mit Tabletten- / Pulverreagenzien	0,2* + 1,0* mg/l
275670	<b>Kit pH</b> für Geräte mit Tabletten- / Flüssigreagenzien	7,45* pH

\* Richtwert, genauer Wert gemäß Analysezertifikat.

## Verwendung eines Verifikationsstandard-Kits (siehe auch Verifikationsstandard-Kit, Seite 22)



drücken und **gedrückt halten**



kurz drücken, loslassen



loslassen.

## DE Überprüfung des Gerätes

AbS

A530

Im Display erscheint kurzzeitig:  
AbS gefolgt von der zu messenden Wellenlänge (z.B. A530 für 530 nm).

Mode

Bei Geräten mit mehreren LEDs die gewünschte Wellenlänge durch ggf. mehrfaches Drücken der Taste [Mode] auswählen (Scrollen).

Zero  
Test

Die mit „Zero“ gekennzeichnete Küvette im Messschacht positionieren. Abdeckkappe aufsetzen und die [Zero/Test]-Taste drücken.

WELLENLÄNGE

blinkt ca. 3 Sekunden

0.0.0

Bestätigung des Nullabgleichs

Zero  
Test

Die mit der gewählten Wellenlänge gekennzeichnete Küvette mehrmals umschwenken und im Messschacht positionieren. Abdeckkappe aufsetzen und die [Zero/Test]-Taste drücken.

WELLENLÄNGE

blinkt ca. 3 Sekunden

ERGEBNIS

Das angezeigte Ergebnis mit dem im Zertifikat eingedruckten Wert unter Berücksichtigung der Toleranzen vergleichen (siehe auch Hinweise im Zertifikat).



Falls das Ergebnis außerhalb der Toleranz liegt und die Standards innerhalb der Haltbarkeit liegen, empfiehlt sich eine Rücksendung des Gerätes an den Hersteller bzw. Händler. Die Überprüfung durch den Hersteller ist sinnvoll, da das Gerät neben der Kalibrierung auch auf technische Mängel geprüft wird.

### Verifikationsstandard-Kit

Die Verifikationsstandards für das MD 100 / MD 110 / MD 200 dienen zur Überprüfung der Nachweisgenauigkeit und Reproduzierbarkeit von Messergebnissen, bezogen auf die integrierten Wellenlängen.

Im Kit enthalten sind eine Nullküvette und 6 verschiedene Messküvetten zur Überprüfung von 6 verschiedenen Wellenlängen. Das Verifikationsstandard-Kit ermöglicht somit die Überprüfung sämtlicher MD 100 / MD 110 / MD 200 Baureihen Photometer.

Die Haltbarkeit der Standards beläuft sich auf zwei Jahre ab Herstellungsdatum bei sachgerechtem Gebrauch und sachgerechter Lagerung. Die Messungen erfolgen in Einheiten von mAbs.

Bestell-Nr.	Artikel
21 56 70	Verifikationsstandard-Kit MD 100 / MD 110 / MD 200



**Technische Daten MD 100, MD 110, MD 200**

Gerät	automatische Wellenlängenwahl, Kolorimeter mit direkter Messwertanzeige
Optik	LEDs, Interferenzfilter (IF) und Photosensor am transparenten Messschacht Wellenlängenspezifikationen der Interferenzfilter abhängig von der Gerätevariante, max. 3 Wellenlängen <u>mögliche verbaute Wellenlängen:</u> 430 nm $\Delta \lambda = 5$ nm 530 nm $\Delta \lambda = 5$ nm 560 nm $\Delta \lambda = 5$ nm 580 nm $\Delta \lambda = 5$ nm 610 nm $\Delta \lambda = 6$ nm 660 nm $\Delta \lambda = 5$ nm
Photometerischer Bereich	-2600 - 2600 mAbs
Wellenlängenrichtigkeit	$\pm 1$ nm
Photometrische Genauigkeit*	3 % FS (T = 20 °C – 25 °C)
Photometrische Auflösung	0,01 A
Auto-OFF	Automatische Geräteabschaltung 10 bzw. 25 Minuten nach letzter Tastenbetätigung (je nach verfügbarer Methode unterschiedliche Reaktionszeiten)
Display	Hintergrundbeleuchtetes LCD (auf Tastendruck)
Uhrzeit	Echtzeituhr und Datum
Justierung	Fabrikations- und Anwenderjustierung. Rückkehr zur Fabrikationsjustierung möglich.
Umgebungsbedingungen	Temperatur: 5–40 °C rel. Feuchte: 30–90 % (nicht kondensierend)
Wasserdicht	schwimmfähig; analog IP 68 (1 Stunde bei 0,1 m)
CE	Zertifikat CE-Konformitätserklärung unter <a href="http://www.lovibond.com">www.lovibond.com</a>

\*gemessen mit Standardlösungen



Die spezifizierte Genauigkeit des Gerätesystems wird nur bei Verwendung der vom Gerätehersteller beigestellten Original-Reagenzsysteme eingehalten.

### Technische Daten MD 100

Batterie	4 Microbatterien (AAA/LR 03)
Betriebszeit	17 h Betriebszeit bzw. 5000 Messungen im Dauertestbetrieb bei ausgeschalteter Hintergrundbeleuchtung
Speicher	interner Ringspeicher für 16 Datensätze
Schnittstelle	IR-Schnittstelle für Messdatenübertragung
Abmessungen	155 x 75 x 35 mm (L x B x H)
Gewicht	Basisgerät ca. 260 g (mit Batterien)

### Technische Daten MD 110

Batterie	4 Microbatterien (AAA/LR 03)
Betriebszeit	17 h Betriebszeit bzw. 5000 Messungen im Dauertestbetrieb bei ausgeschalteter Hintergrundbeleuchtung und ohne Benutzung der Bluetooth® Datenübertragung
Speicher	interner Ringspeicher für 125 Datensätze
Schnittstellen	Bluetooth® 4.0 für die Übertragung gespeicherter Messdaten
Bluetooth® Modul:	Spezifikationen: Modul: BLE113-A Bluetooth® 4.0 LE FCC ID: QOQBT113 IC: 5123A-BGTBLE113
Abmessungen	155 x 75 x 35 mm (L x B x H)
Gewicht	Basisgerät ca. 260 g (mit Batterien)

### Technische Daten MD 200

Batterie	4 Batterien (Mignon AA/LR 6)
Betriebszeit	53 h Betriebszeit bzw. 15000 Messungen im Dauertestbetrieb bei ausgeschalteter Hintergrundbeleuchtung
Speicher	interner Ringspeicher für 16 Datensätze
Schnittstelle	IR-Schnittstelle für Messdatenübertragung
Abmessungen	190 x 110 x 55 mm (L x B x H)
Gewicht	Basisgerät ca. 455 g (mit Batterien)

## Bedienerhinweise

Hi

Messbereich überschritten oder Trübung zu groß.

Lo

Messbereich unterschritten.



Batterien umgehend austauschen, Weiterarbeiten nicht möglich.

btLo

Batteriespannung für Hintergrundbeleuchtung zu niedrig, Messung jedoch möglich.

Store  
Cal  
Date  
time  
**ERGEBNIS**  
Cal

Bei einer Methode, die durch den Anwender justiert wurde, wird bei Anzeige des Ergebnisses im Display ein Pfeil in der Position Cal angezeigt (siehe „Rückkehr zur Fabrikationsjustierung“).

## Fehlermeldungen

E27 / E28 / E29

Lichtabsorption zu groß. Ursache z.B.: verschmutzte Optik.

E 10 / E 11

Justierfaktor außerhalb des zulässigen Bereiches.

E 20 / E 21

Detektor empfängt zuviel Licht.

E23 / E24 / E25

Detektor empfängt zuviel Licht.

E 22

Während der Messung war die Batterieleistung zu gering.  
Batterie austauschen.

E 70

Diese Fehlermeldungen beziehen sich auf eine fehlende oder defekte Fabrikations- oder Anwenderjustierung. Bitte setzen Sie sich mit unserem Technischen Support unter [techsupport@tintometer.de](mailto:techsupport@tintometer.de) in Verbindung.

E 71

E 72

⋮

• <b>Important Information</b> . . . . .	29
• <b>General notes</b> . . . . .	30
Guidelines for photometric measurements . . . . .	30
Method notes . . . . .	30
Placing the seal ring . . . . .	31
Placing the seal cap . . . . .	31
Positioning the adapter . . . . .	31
Positioning the vials . . . . .	31
Correct filling of the vial . . . . .	31
Correct handling of the reagents . . . . .	31
Replacement of batteries . . . . .	32
• <b>Functional description</b> . . . . .	33
Operation . . . . .	33
Scroll Memory . . . . .	33
Performing Zero . . . . .	33
OTZ . . . . .	34
Performing test procedure . . . . .	34
Display backlight . . . . .	34
Countdown / reaction period . . . . .	35
Recall of stored data . . . . .	35
• <b>Menu options</b> . . . . .	36
Retrieve menu . . . . .	36
Menu selections . . . . .	36
Recall of stored data . . . . .	36
Transmitting stored data - to printer or PC® - at the MD 100 and MD 200 . . . . .	37
Transmitting stored data Bluetooth® - at the MD 110 . . . . .	38
Setting date and time . . . . .	39
• <b>User calibration</b> . . . . .	40
Display of current calibration setting . . . . .	40
User calibration . . . . .	40
Calibration Mode for Fluoride . . . . .	42
Factory calibration reset . . . . .	43
• <b>Checking the device</b> . . . . .	44
Use a reference standard kit . . . . .	44
Use of a verification standard kit . . . . .	45
• <b>Technical data</b> . . . . .	47
• <b>Operating messages</b> . . . . .	49
• <b>Error codes</b> . . . . .	49

## Important Information for consumers in the EU

### Disposal instructions for batteries and accumulators



EC Guideline 2006/66/EC requires users to return all used and worn-out batteries and accumulators. They must not be disposed of in normal domestic waste. Because our products include batteries and accumulators in the delivery package our advice is as follows : Used batteries and accumulators are not items of domestic waste. They must be disposed of in a proper manner. Your local authority may have a disposal facility; alternatively you can hand them in at any shop selling batteries and accumulators. You can also return them to the company which supplied them to you; the company is obliged to accept them.

### Disposal of Electrical Equipment



Because of the European Directive 2012/19/EU your electrical instrument must not be disposed of with normal household waste! We will dispose of your electrical instrument in a professional and environmentally responsible manner. This service, excluding the cost of transportation is free of charge. This service only applies to electrical instruments purchased after 13th August 2005. Send your electrical Tintometer instrument for disposal freight prepaid to your supplier.

## Safety - General instructions

The manufacturer's liability and warranty for damage and consequential damages lapses with improper use, failure to follow this operating manual, use of insufficiently qualified specialized personnel or unauthorized changes to the instrument. The manufacturer is not liable for costs or damages that arise for the user or third parties due to the use of this instrument, especially in case of improper use of the instrument or misuse or faults in the connection or of the instrument. The manufacturer assumes no liability for print errors.

## Safety information in the operating manual

This operating manual provides important information on the safe operation of the product. Read this operating manual thoroughly and make yourself familiar with the product before putting it into operation or working with it. The operating manual must be kept in the vicinity of the product so you can always find the information you need.



**Note:**

The description of the methods and reagent handling is not included in this manual. They are on the supplied storage media or can be downloaded from our website.

## Guidelines for photometric measurements

1. Vials, caps and stirring rods should be cleaned thoroughly **after each analysis** to prevent interference. Even minor reagent residues can cause errors in the test result.
2. The outside of the vial must be clean and dry before starting the analysis. Clean the outside of the vials with a towel to remove fingerprints or other marks.
3. Zero calibration and test must be carried out with the same vial as there may be slight differences in optical performance between vials.
4. The vials must be positioned in the sample chamber for zeroing and test with the  $\Delta$  mark on the vial aligned with the  $\nabla$  mark on the instrument.
5. Always perform zeroing and test with the vial cap tightly closed. Only use the cap with a sealing ring.
6. Bubbles on the inside wall of the vial lead to incorrect measurements. To prevent this, remove the bubbles by swirling the vial before performing the test.
7. Avoid spillage of water into the sample chamber because this can lead to incorrect test results.
8. Contamination of the transparent cell chamber can result in wrong readings. Check at regular intervals and – if necessary – clean the transparent cell chamber using lint-free, moist cloths (oil-free) or cotton buds.
9. Large temperature differences between the instrument and the environment can lead to errors – e.g. due to the formation of condensation in the cell chamber or on the vial.
10. To avoid errors caused by stray light do not use the instrument in bright sunlight.
11. Always add the reagent tablets to the water sample straight from the foil without touching them with the fingers.
12. The reagents must be added in the correct sequence.

## Method notes

- Prior to measurement ensure that the sample is suitable for analysis (no major interferences) and does not require any preparation i.e. pH adjustment, filtration etc.
- Different Refill Packs available on request.
- Reagents are designed for use in chemical analysis only and should be kept well out of the reach of children.
- Ensure proper disposal of reagent solutions.
- Material Safety Data Sheets are available on request (Internet: [www.lovibond.com](http://www.lovibond.com))

**Placing the seal ring:**



**Placing the seal cap:**

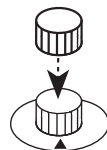

**Positioning the adapter:**

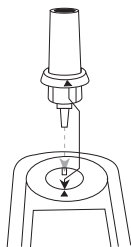

**Positioning the vials:**

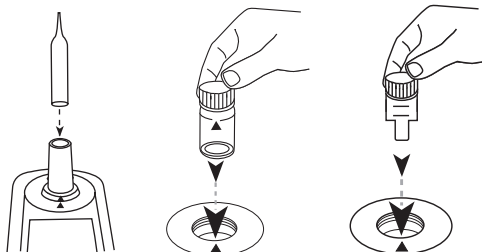

**Correct filling of the vial:**

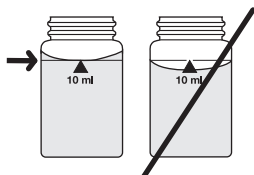

**Correct handling of the reagents:**

**Powder Packs**

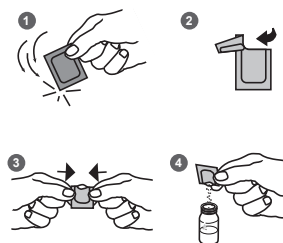

**Liquid reagents**

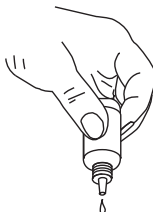

**Blister-tablets**

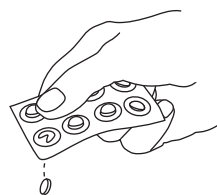

**Replacement of batteries:**

**MD 100 / MD 110**

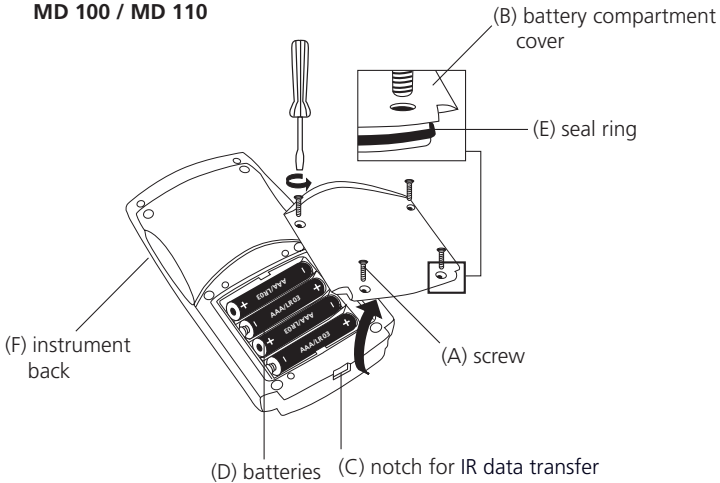

**MD 200**

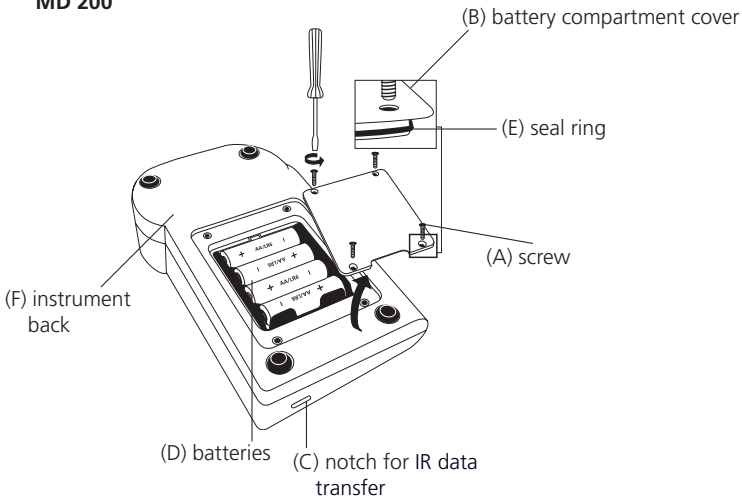

**CAUTION:**

**To ensure that the instrument is water proof:**

- seal ring (E) must be in position
- battery compartment cover (B) must be fixed with the four screws

If the batteries are removed for more than one minute the date and time menu starts automatically when the photometer is switched on the next time.



## Operation



Switch the unit on



Selecting a method



### Scroll Memory (SM)

To avoid unnecessary scrolling for the required test method, the instrument memorizes the last method used before being switched off. When the instrument is switched on again, the scroll list comes up with the last used test method first.



### Note:

The description of the methods and reagent handling is not included in this manual; it is contained in a separate document.



### Fluoride method

#### Caution:

A calibration of the method has to be performed before the first use (see ▼ calibration mode Fluoride). The same batch of SPADNS reagent solution must be used for adjustment and test. The adjustment process needs to be performed for each new batch of SPADNS reagent solution.

## Performing zero

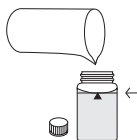

Fill 24 mm vial with 10 ml sample

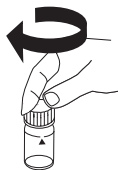

Close vial



Place sample vial in the sample chamber.  
Pay attention to the positioning.

## GB Functional description



Press [ZERO/TEST] button

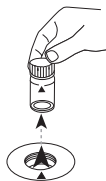

Remove the vial from the sample chamber

### OTZ (One Time Zero)

The One Time Zero is available for all photometer variants whereby the zero adjustment is carried out in a 24-mm round vial with sample water. It can be used if different tests are carried out with identical test conditions and the same water sample. When changing methods, it is not necessary to carry out another zero adjustment; the next test can begin immediately. The zero adjustment is saved until the device is switched off.

The zero setting can be repeated each time if necessary.



One Time Zero (OTZ), 1x performing zero, then parameter measurement



Repeating the zero, Press the key for 2 seconds.

### Performing test procedure

Add reagent (f.e. a reagent tablet) (see method description)



Close vial



Place sample vial in the sample chamber.  
Pay attention to the positioning.



Press [ZERO/TEST] button

### Display backlight



press, the backlight is switched off automatically during the measurement

## Countdown / reaction period

For methods with a reaction time, a countdown function can be switched on during the test for some methods.

press and hold

press

release

Countdown/reaction time runs, measurement takes place automatically after the time runs out.

Interrupt countdown/reaction time

### Attention:

**Non-compliance with reaction periods leads to incorrect test results.**



### Note:

The description of the methods and reagent handling is not included in this manual; it is contained in a separate document.



## Recall of stored data

The device has a ring memory. The last 16 measured values can be retrieved.



Switch the unit on



press for more than 4 seconds , then release, to access the recall menu



Scroll through data sets



Repeat the data set



Return to measurement mode

Display in the following format (automatically proceeds every 3 seconds until result is displayed):

Number n xx (xx: 16...1)  
Year YYYY (e.g. 2014)  
Date mm.dd (monthmonth:dayday)  
Time hh:mm (hourhour:minute)  
Test Method  
Result x.xx

## Retrieve menu

Device is switched off

press and hold

press briefly, release

release



## Menu selections

press to select a menu point (scroll)

Selection of the following menu points:

diS recall stored data

Prt printing stored data

setting the date and time

user calibration

The selected menu is indicated by an arrow in the display.

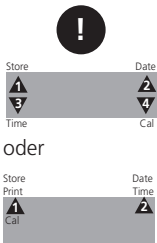

depending on  
device variant

## diS – Recall of stored data

Retrieve menu (see "Retrieve menu")

Scroll through data sets

Repeat the data set

Return to measurement mode

The device has a ring memory. The last 16 measured values can be retrieved.

Display in the following format (automatically proceeds every 3 seconds until result is displayed):

Number n xx (xx: 16...1)  
Year YYYY (e.g. 2014)  
Date mm.dd (month:day)  
Time hh:mm (hour:minute)  
Test Method  
Result x.xx





## ⚠ Prt – Transmitting stored data - to Printer or PC - at the MD 100 and MD 200



**Attention:** To print data, or to transmit to a PC, the optional IRiM (Infrared Interface Module) is required. It can be used in combination with the devices MD 100 and MD 200.

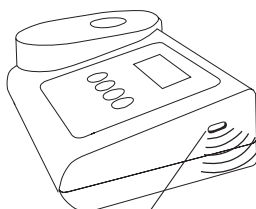
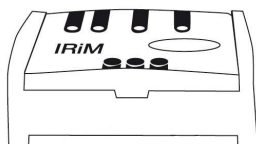

notch for IR data transfer



**PrtG**



**E 162**

Retrieve menu (see "Retrieve menu")

press

The IRiM Module and the connected printer/PC must be ready. The instrument displays "PrtG" (Printing) for approx. 1 second.

press

All data sets will be transmitted one after the other. After finishing the instrument switches to test mode.

The print job can be cancelled by pressing the [On/Off] key. The instrument switches off.

If the instrument is not able to communicate with the IRiM, a timeout occurs after approx. 2 minutes. The error E 132 is displayed for approx. 4 seconds. Subsequently, the instrument switches to test mode (see also IRiM manual).



**▲ Prt – Transmitting stored data - Bluetooth® - at the MD 110**

The MD 110 has a Bluetooth® 4.0 interface which enables the wireless transmission of data. Now it is possible to transmit stored results. Bluetooth® 4.0 is also known as Bluetooth® Smart or Bluetooth® LE (Low Energy). Data is transmitted from the photometer as a .csv file. Details on how information is transmitted from the photometer can be found on [www.lovibond.com](http://www.lovibond.com). To receive the data, there are several options on offer from the Tintometer® Group.

The App, AquaLX®, is available for mobile devices such as Smartphones and Tablets and enables the user to manage and graphically chart the received data. Both the data and charts can then be shared via email. AquaLX® can be downloaded free of charge from the iTunes Store® for iOS® and from Google Play™ Store for Android™.

A software tool is available for PCs to receive data stored on the photometer. The data can be exported to an Excel® spreadsheet which enables users to process the information according to their usual practice. If Excel® is not available, the data can be stored as a .txt file for processing at a later date. A Bluetooth® dongle is required to receive the data. This is part of the delivery content of the software.

Description	Part Number
Software, incl. Bluetooth® Dongle	2444480

Retrieve menu (see “Retrieve menu”)



press



press

Peripherals must be ready.

The display shows the status of the Bluetooth® connection.

The display shows: „ncon” (not connecting).



If necessary an update of the list of recognized devices in the software on the peripheral devices may be required. See therefor the instruction of the AquaLX or the data transmission software for the bluetooth® dongle.



The display shows: „con” (connecting).



Press the [MODE] key to start the transmission, the instrument shows “PrtG” (Printing) during the data transmission and connection.



All data sets will be transmitted one after the other. The measurement results are saved on the photometer. After finishing the instrument switches to test mode and the Bluetooth® connection is interrupted.



The transfer can be cancelled at any time by pressing the [On/Off] key. The instrument switches off.



### Setting date and time (24-hour-format)

Retrieve menu (see "Retrieve menu")



2x press = arrow symbols on Time & Date



confirm



Increase value



Decrease value



Confirm the respective setting



"IS SET" appears on the display after the final confirmation.

The instrument returns to the measurement mode.

## Display of current calibration setting

### Retrieve menu (see "Retrieve menu")



3x = arrow symbols on Cal or Cal on the display

confirm

Display alternates between: CAL/„Methode“.

### Note:

User calibration

Factory calibration

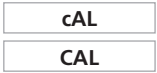

## 4 User calibration

Retrieve menu (see "Retrieve menu")

3x = arrow symbols on Cal or Cal on the display

confirm

Display alternates between: CAL/„Methode“.



selecting a method



Fill 24 mm vial with 10 ml sample.

The sample should consist of colourless and unclouded water (e.g. deionised water, pure drinking water).

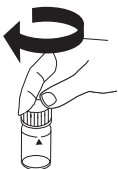

close vial



## GB User calibration



Place the vial in the sample chamber.  
Pay attention to the positioning.

press



flashes for approx. 8 seconds

0.0.0

CAL

The display shows the following in alternating mode:

Zero  
Test

Perform the measurement with a known standard concentration.

press



flashes for approx. 3 seconds

RESULT

CAL

The result is shown in the display, alternating with CAL.

If the result matches the value of the standard used (within the relevant tolerance), exit calibration mode.

On  
Off

press

If the result is outside of the value (taking into account the tolerance), change the displayed value:

Mode

Press 1 x increases the displayed value by 1 digit.

Zero  
Test

Press 1 x decreases the displayed value by 1 digit.

Press the corresponding key until the reading equals the value of the calibration standard.

CAL

RESULT + x

The result is shown in the display, alternating with CAL.

On  
Off

press for more than 4 seconds

The user calibration is calculated and stored.

## **4** Calibration Mode for Fluoride

### **Calibration takes place also:**

0 mg/l and 1.0 mg/l F<sup>-</sup> standard and a clean vial  
(see method description, rem.)

### **Fluoride calibration:**

Retrieve menu (see “Retrieve menu”)



3x = arrow symbols on Cal or Cal on the display

confirm



After confirming the selection with the [MODE] key the instrument will show CAL/F.

Fill a clean vial with 10 ml deionised water, close tightly with the cap.

Place the vial in the sample chamber making sure that the  $\times$  marks are aligned.

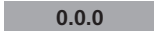

Press the [ZERO/TEST] key.

The method symbol flashes for approx. 8 seconds.

The display shows the following in alternating mode:

Add **exactly 2 ml SPADNS reagent solution** to the deionised water. Close the vial tightly with the cap and invert several times to mix the contents.

Place the vial in the sample chamber making sure that the  $\times$  marks are aligned.



Press the [ZERO/TEST] key.

The method symbol flashes for approx. 3 seconds.

The display shows:

Remove the vial from the sample chamber, empty the vial, rinse vial and cap several times and then fill the vial with **exactly 10 ml Fluoride standard (Concentration 1 mg/l F)**.

Add **exactly 2 ml SPADNS reagent solution** to the Fluoride standard. Close the vial tightly with the cap and invert several times to mix the contents.

Place the vial in the sample chamber making sure that the  $\times$  marks are aligned.



Press the [ZERO/TEST] key.

The method symbol flashes for approx. 3 seconds.

## GB User calibration

F1



:

The display shows:

By pressing the [ON/OFF] key, the new correction factor is calculated and stored in the user calibration software.

Confirmation of calibration (3 seconds).



SEL

CAL

### Factory calibration reset

Resetting the user calibration to the original factory calibration will reset all methods and ranges.

A user calibrated method is indicated by an arrow while the test result is displayed.

In order to reset the device to the factory calibration, proceed as follows:

press and **and hold both**

press briefly, release

release approx. 1 second.

The following messages will appear in turn on the display:

Factory calibration

**oder:**

User calibration

SEL

cAL



Calibration is reset to the factory setting by pressing the [MODE] key.

SEL

CAL

The following messages will appear in turn on the display:



Switch the unit off.

## GB Checking the device



### Use a reference standard kit (see page 41 Reference standards-Kits for MD 100, MD 110 and MD 200)

Use the photometer as described in the instructions for the method which correspond with normally used reagent system (tablet, liquid reagent or powder pack). For liquid reagent use the tablet mode.



Switch the unit on.



Selecting a method.



Place the Reference standard „Zero“ vial in the sample chamber. Pay attention to the positioning.

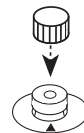

Close with the rubber seal cap.



Press the [ZERO/TEST] key.

0.0.0

Confirm the zero adjustment

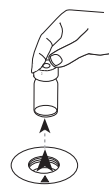

Remove the vial from the sample chamber.



Set the reference standard for the corresponding method in the sample chamber. Pay attention to the positioning.



Press the [ZERO/TEST] key.

RESULT

The result is compared with the value documented on the test certificate, taking into account the tolerances (standard & device). Ensure the selected reagent systems are correctly assigned.

## Checking the device



If the result falls outside of the tolerance, the shelf life of the standard must be checked as well as whether the photometer is in the factory calibration. If this applies, we recommend returning the device to the manufacturer or distributor.

### Reference standards-Kits for MD 100, MD 110 and MD 200

The reference standards are only used to check the measurement accuracy for the photometers listed in the test certificate. The calibration of these devices is stable in the long term under normal working conditions. The photometer cannot be calibrated with the reference standard.

The reference standards are delivered in tightly sealed vials.

The target values for each standard are documented in the certificate. The shelf life of the reference standard is two years from the date of manufacture, provided it is used and stored correctly. The outside of the vials must always be cleaned with a clean cloth before use.

Part-Number	Material	range
275650	<b>Kit chlorine</b> for devices with tablet/ liquid reagents	0,2* + 1,0* mg/l
275655	<b>Kit chlorine</b> for devices with tablet/ liquid reagents	0,5* + 2,0* mg/l
275656	<b>Kit chlorine</b> for devices with tablet/ liquid reagents	1,0* + 4,0* mg/l
275660	<b>Kit chlorine</b> for devices with tablet / powder reagents	0,2* + 1,0* mg/l
275670	<b>Kit pH</b> for devices with tablet / liquid reagents	7,45* pH

\* Standard value, exact value according to the analysis certificate.

### Use of a verification standard kit (see also verification standard kit, page 44)



press and **and hold**



press briefly, release



release

## GB Checking the device

AbS

A530

The following appears briefly on the display:  
AbS followed by the wavelength to be measured (e.g. A530 for 530 nm).

Mode

For devices with several LEDs, select the desired wavelength by pressing the [Mode] button several times as needed (scroll).

Zero  
Test

Position the vial marked "Zero" in the sample chamber. Place the seal cap and press the [Zero/Test] button.

wavelength

flashes for approx. 3 seconds

0.0.0

Confirm the zero adjustment

Zero  
Test

Swirl the vial marked with the selected wavelength several times and position it in the sample chamber. Close with the rubber seal cap and press [Zero/Test].

wavelength

flashes for approx. 3 seconds

RESULT

Compare the displayed result with the value printed on the certificate, taking into account the tolerances (see also notes on the certificate).



If the result falls outside of the tolerance and the standards are within the expiration date, we recommend returning the device to the manufacturer or distributor. It is useful to have the manufacturer perform an inspection, as this means the device is checked for technical faults in addition to the calibration.

### Verifikationsstandard-Kit

The verification standards for the MD 100 / MD 110 / MD 200 serve to check the accuracy and reproducibility of measurement results based on the integrated wavelengths.

The kit includes a blank and 6 different measuring vials to check 6 different wavelengths. The verification standard kit thus enables the inspection of all MD 100 / MD 110 / MD 200 series photometers.

The shelf life of the standard is two years from the date of manufacture, provided it is used and stored correctly. The measurements are made in units of mAbs.

Part-Number	Material
21 56 70	Verifikationsstandard-Kit MD 100 / MD 110 / MD 200

**Technical Data MD 100, MD 110, MD 200**

Instrument	automatic wavelength selection, direct reading colorimeter
Light source	LEDs, interference filters (IF) and photosensor in transparent cell chamber Wavelength specifications of the interference filter dependent on the device variant, max. 3 wave lengths Possible built-in wavelengths: 430 nm $\Delta \lambda = 5$ nm 530 nm $\Delta \lambda = 5$ nm 560 nm $\Delta \lambda = 5$ nm 580 nm $\Delta \lambda = 5$ nm 610 nm $\Delta \lambda = 6$ nm 660 nm $\Delta \lambda = 5$ nm
Photometric Range	-2600 - 2600 mAbs
Wavelength accuracy $\pm 1$ nm	
Photometric accuracy*	3 % FS (T = 20 °C – 25 °C)
Photometric resolution	0,01 A
Auto-OFF	automatic switch off 10 respectively 25 minutes after last keypress (different reaction times depending on available method)
Display	backlit LCD (on keypress)
Time	real time clock und date
Calibration	user and factory calibration resetting to factory calibration possible
Ambient conditions	temperature: 5–40 °C rel. humidity: 30–90 % (non-condensing)
Waterproof	floating; as defined in IP 68 (1 hour at 0.1 meter)
CE	Certificate for Declaration of CE-Conformity at <a href="http://www.lovibond.com">www.lovibond.com</a>

*\*measured with standard solutions*



To ensure maximum accuracy of test results, always use the reagent systems supplied by the instrument manufacturer..

**Technical Data MD 100**

Batteries	4 micro batteries (AAA/LR 03)
Operating time	17hr operating time or 5000 test measurements in continuous mode when display backlight is off
Storage	internal ring memory for 16 data sets
Serial Interface	IR interface for data transfer
Dimensions	155 x 75 x 35 mm (LxWxH)
Weight	Base unit approx. 260 g (with batteries)

**Technical Data MD 110**

Batteries	4 micro batteries (AAA/LR 03)
Operating time	17hr operating time or 5000 measurements in constant use when display backlight and Bluetooth® data transfer are off.
Storage	internal ring memory for 125 data sets
Serial Interface	Bluetooth® 4.0 for the transfer of stored measurement data
Bluetooth® Modul:	Specifications: Modul: BLE113-A Bluetooth® 4.0 LE FCC ID: QOQBT113 IC: 5123A-BGTBLE113
Dimensions	155 x 75 x 35 mm (LxWxH)
Weight	Base unit approx. 260 g (with batteries)

**Technical Data MD 200**

Batteries	4 Batteries (Mignon AA/LR 6)
Operating time	53hr operating time or 15000 test measurements in continuous mode when display backlight is off
Storage	internal ring memory for 16 data sets
Serial Interface	IR interface for data transfer
Dimensions	190 x 110 x 55 mm (LxWxH)
Weight	Base unit approx. 455 g (with batteries)



## Operating messages

Hi

Measuring range exceeded or excessive turbidity.

Lo

Result below the lowest limit of the measuring range.



Replace batteries, no further tests possible.

btLo

Battery capacity is too low for the display backlight; measurement is still possible.

Store Cal Date  
Cal RESULT Cal  
Time

A user calibrated method is indicated by an arrow while the test result is displayed (see "Factory calibration reset").

## Error codes

E27 / E28 / E29

Light absorption too great. Reasons: e.g. dirty optics.

E 10 / E 11

Calibration factor "out of range"

E 20 / E 21

Too much light reaching the detector.

E23 / E24 / E25

Too much light reaching the detector.

E 22

Battery capacity was too low during measurement. Change battery.

E 70

These error messages relate to a missing or faulty factory or user calibration. Please contact our Technical Support at [techsupport@tintometer.de](mailto:techsupport@tintometer.de).

E 71

E 72

⋮

• <b>Notice Importante</b> .....	51
• <b>Informations générales</b> .....	52
Informations sur la technique de travail .....	52
Consignes relatives aux méthodes .....	52
Pose du joint d'étanchéité .....	53
Pose du capuchon .....	53
Positionnement de l'adaptateur .....	53
Positionnement des cuves .....	53
Remplissage correct de la cuvette .....	53
Comment manipuler les réactifs .....	53
Remplacement des piles .....	54
• <b>Fonctionnalités</b> .....	55
Mise en service .....	55
Scroll Memory (SM) .....	55
Procéder au calage du zéro .....	55
OTZ (One Time Zero) .....	56
Effectuer la procédure de test .....	56
Affichage rétro-éclairé .....	56
Compte à rebours / durée de réaction .....	57
Lecture de données mémorisées .....	57
• <b>Menu options</b> .....	58
Sélection menu .....	58
Sélection menu .....	58
Lecture de données mémorisées .....	58
Transmettre des données mémorisées - vers une imprimante ou un PC - pour le MD 100 et MD 200 .....	59
Transmettre des données mémorisées - Bluetooth® - pour le MD 110 .....	60
Réglage de la date et de l'heure (format 24 heures) .....	61
• <b>Réglage par l'utilisateur</b> .....	62
Affichage de l'ajustage actuel .....	62
Réglage par l'utilisateur .....	62
Mode de réglage pour le fluorure .....	64
Retour au réglage usine .....	65
• <b>Contrôle de l'appareil</b> .....	66
Utilisation d'un kit étalon de référence .....	66
Utilisation d'un kit d'étalons de vérification .....	67
• <b>Caractéristiques techniques</b> .....	69
• <b>Informations à l'utilisateur</b> .....	71
• <b>Messages d'erreur</b> .....	71

## Notice importante pour les consommateurs de l'UE

### Information pour l'élimination des piles et des accumulateurs



En vertu de la Directive européenne 2006/66/CE relative aux piles et accumulateurs, chaque utilisateur est tenu de restituer toutes les piles et tous les accumulateurs utilisés et épuisés. L'élimination avec les déchets ménagers est interdite. Etant donné que l'étendue de livraison des produits de notre gamme contient également des piles et des accumulateurs, nous vous signalons ce qui suit : les piles et les accumulateurs utilisés ne sont pas des ordures ménagères, ils peuvent être remis sans frais aux points de collecte publics de votre municipalité et partout où sont vendus des piles et accumulateurs du type concerné. Par ailleurs, l'utilisateur final a la possibilité de remettre les piles et les accumulateurs au commerçant auprès duquel ils ont été achetés (obligation de reprise légale).

### Élimination du matériel électrique



Conformément à la directive européenne n° 2012/19/UE, vous ne devez plus jeter vos instruments électriques dans les ordures ménagères ordinaires ! Nous se charge d'éliminer vos instruments électriques de façon professionnelle et dans le respect de l'environnement. Ce service, qui ne comprend pas les frais de transport, est gratuit. Ce service n'est valable que pour des instruments électriques achetés après le 13 août 2005. Nous vous prions d'envoyer votre instrument électrique Tintometer utilisé à vos frais par votre fournisseur.

## Sécurité - Instructions générales

La responsabilité du fabricant pour les dommages directs et indirects et la garantie correspondante expirent en cas d'utilisation non conforme à l'usage prévu, de non-respect de ce manuel d'utilisation, de l'emploi de personnel technique insuffisamment qualifié et de modification non autorisée de l'appareil. Le fabricant n'est pas responsable des coûts et dommages subis par l'utilisateur ou des tiers en raison de l'utilisation de l'appareil, en particulier en cas d'utilisation non conforme de ce dernier ou en cas d'emploi abusif ou de dysfonctionnements du branchement ou de l'appareil. Le fabricant n'est pas responsable des erreurs d'impression.

## Informations de sécurité dans la notice d'utilisation

Cette notice d'utilisation contient des informations importantes pour une utilisation du produit en toute sécurité. Lisez cette notice d'utilisation dans son intégralité et familiarisez-vous avec le produit avant de le mettre en service ou de travailler avec lui. Gardez toujours la notice d'utilisation à portée de main afin de pouvoir la consulter en cas de besoin.



### Remarque :

La description des méthodes et la manipulation des réactifs ne font pas partie de ce mode d'emploi. Ils se trouvent sur le support de données joint ou peuvent être téléchargés de notre site web.

## Informations sur la technique de travail

1. Les cuvettes, les couvercles et agitateurs doivent être soigneusement nettoyés **après chaque analyse** afin d'éviter des erreurs dues à des résidus. De faibles traces de réactifs suffisent à fausser les mesures.
2. Les parois extérieures des cuvettes doivent être nettoyées et essuyées avant de procéder à l'analyse. Les traces de doigt ou gouttes d'eau sur les surfaces de passage de la lumière des cuvettes provoquent des erreurs de mesure.
3. Il convient de réaliser le calage du zéro et le test avec la même cuvette, car les cuvettes peuvent présenter de légers écarts entre elles.
4. La cuvette doit toujours être placée, pour le calage du zéro, dans la chambre de mesure, de telle manière que la graduation avec le triangle blanc soit tournée vers le repère du boîtier.
5. Le couvercle de la cuvette doit être fermé lors du calage du zéro et pendant le test. Il doit être pourvu d'un joint d'étanchéité.
6. La formation de gouttelettes sur les parois intérieures de la cuvette provoque des erreurs de mesure. Dans ce cas, il convient de fermer la cuvette avec son couvercle et de dissoudre les gouttelettes en l'agitant avant de procéder au test.
7. Il faut éviter de laisser pénétrer de l'eau dans la chambre de mesure car cela peut provoquer des erreurs de mesure.
8. Des saletés dans le compartiment de mesure transparent entraînent des erreurs de mesure. Vérifier à des intervalles de temps réguliers les surfaces de pénétration de la lumière du compartiment de mesure transparent et nettoyer ces dernières le cas échéant. Pour le nettoyage, utilisez de préférence des chiffons humides, non pelucheux (non huileux) et des cotons-tiges..
9. Des différences de température relativement importantes entre le photomètre et son environnement peuvent entraîner des erreurs de mesure, par exemple en raison de la formation d'eau de condensation dans la chambre de mesure et à la cuvette.
10. Lors de son fonctionnement, protéger l'appareil de l'impact direct des rayons du soleil.
11. Les pastilles de réactif doivent être ajoutées directement de leur emballage protecteur dans l'échantillon d'eau sans entrer en contact avec les doigts.
12. Il convient de suivre scrupuleusement l'ordre d'apport des pastilles.

## Consignes relatives aux méthodes

- Tenir compte des possibilités d'utilisation, des instructions d'analyse et des effets de matrice des méthodes.
- Différents packs de recharge sont disponible sur demande.
- Les réactifs sont destinés aux analyses chimiques et ne doivent en aucun cas être laissés entre des mains d'enfants.
- Eliminer les solutions de réactif conformément à la législation.
- En cas de besoin, demander des fiches de données de sécurité.  
(Internet: [www.lovibond.com](http://www.lovibond.com))

**Pose du joint d'étanchéité :**



**Pose du capuchon :**

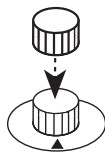

**Positionnement de l'adaptateur :**

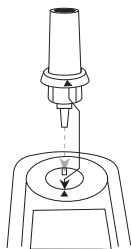

**Positionnement des cuves :**

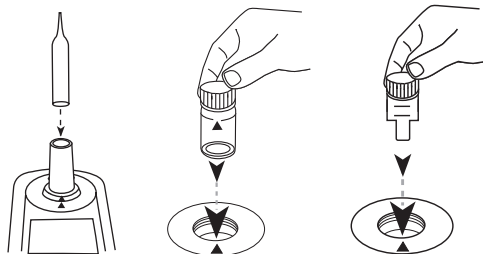

**Remplissage correct de la cuvette:**

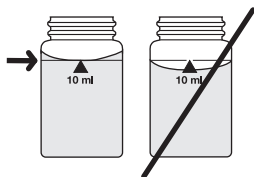

**Comment manipuler les réactifs :**

**Sachet de poudre**

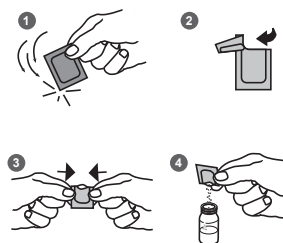

**Réactifs liquides**

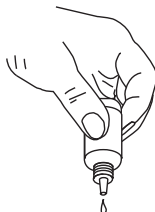

**Pastilles en plaquette**

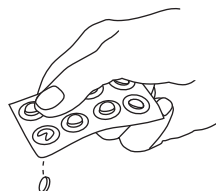

**Remplacement des piles:**

**MD 100 / MD 110**

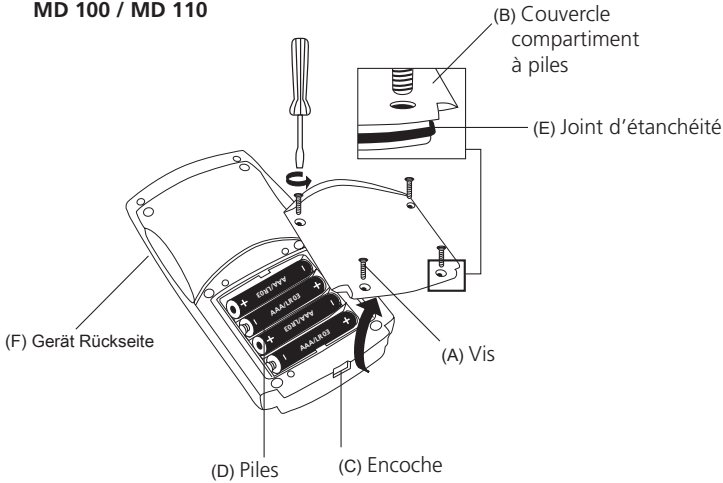

**MD 200**

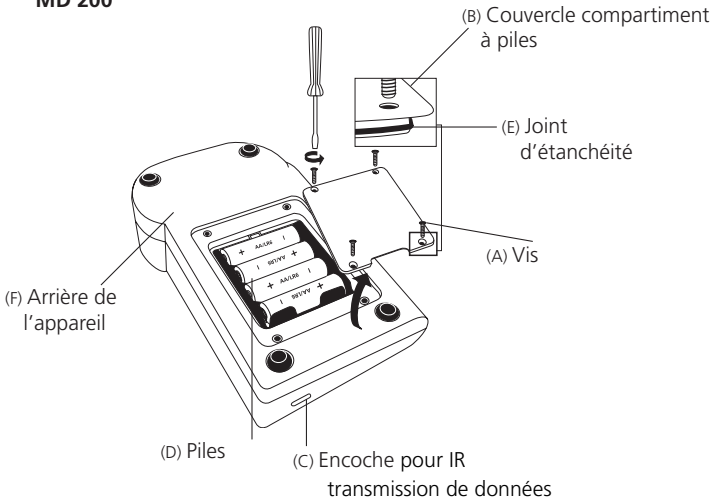

**ATTENTION:**

**Pour garantir une parfaite étanchéité du photomètre, placer le joint d'étanchéité en position (E) et visser le couvercle du compartiment à piles (B).**

Si la pile est enlevée de l'appareil pendant plus d'une minute, le programme de date-heure apparaît automatiquement dès le démarrage de l'appareil, au rétablissement de l'alimentation en tension (insertion de la nouvelle pile).

## Mise en service



Mettre en marche l'appareil



Sélectionner méthodes



### Scroll Memory (SM)

Dans les appareils multiparamétriques, l'ordre des différentes méthodes est défini. Après la mise en marche de l'appareil, ce dernier affiche automatiquement la méthode qui avait été sélectionnée en dernier avant l'arrêt de l'appareil. De cette manière, l'appareil permet un accès privilégié aux méthodes préférées.



### Remarque:

La description des méthodes et la manipulation des réactifs ne font pas partie de ce mode d'emploi. Elles figurent dans un document séparé.



### Méthode Fluorure

#### ATTENTION!

Avant la mise en service initiale, il faut procéder à un ajustage de la méthode (voir «Sélection menu»: ▼ Mode de réglage pour le fluorure). Il faut utiliser le même batch de solution réactive SPADNS pour l'ajustement et la mesure de l'échantillon. Procéder pour chaque nouveau batch de solution réactive à un nouvel ajustement de l'appareil.

## Procéder au calage du zéro

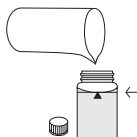

Remplissez une cuvette de 24 mm de 10 ml d'échantillon.

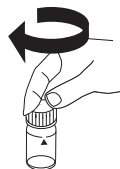

Fermez la cuvette.

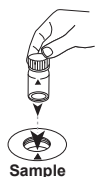

Placez la cuvette réservée à l'échantillon dans la chambre de mesure. Attention à la positionner correctement.



Appuyez sur la touche [ZERO/TEST].



Retirez la cuvette de la chambre de mesure.

### **OTZ (One Time Zero)**

La fonction One-Time-Zero est disponible sur toutes les versions de photomètre dans lesquelles le réglage du zéro est effectué avec l'eau d'échantillonnage dans une cuve ronde de 24 mm. Elle peut être utilisée pour effectuer différents tests dans des conditions identiques, avec le même échantillon d'eau. Lors d'un changement de méthode, il n'est alors plus nécessaire de refaire un nouveau réglage du zéro ; pour passer directement au test. Le réglage du zéro est sauvegardé jusqu'à l'arrêt de l'appareil.

Une nouvelle compensation à zéro peut être effectuée à tout moment si elle s'avère nécessaire.



One Time Zero (OTZ), 1x réglage du zéro puis mesure des paramètres



Nouveau calage du zéro, Appuyez sur la touche pendant 2 secondes

### **Effectuer la procédure de test**

Ajouter (p.e. pastilles de réactif) (voir description de la méthode)



Fermez la cuvette.

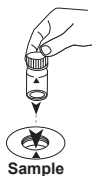

Placez la cuvette réservée à l'échantillon dans la chambre de mesure. Attention à la positionner correctement.



Appuyez sur la touche [ZERO/TEST].

### **Affichage rétro-éclairé**



Appuyez , pendant l'opération de mesure, le rétro-éclairage se désactive automatiquement.



## Compte à rebours / durée de réaction

Dans certaines méthodes nécessitant un temps de réaction, il est possible d'activer une fonction de compte à rebours au cours du test. Appuyez et **la maintenir enfoncée**.



Appuyez

Lâcher

Le compte à rebours / temps de réaction est activé, la mesure a lieu automatiquement après écoulement de la durée définie.



Interrompre le compte à rebours / temps de réaction



### Attention:

**le non respect de la durée de réaction peut provoquer des erreurs de mesure.**

### Remarque:

La description des méthodes et la manipulation des réactifs ne font pas partie de ce mode d'emploi. Elles figurent dans un document séparé.



## Lecture de données mémorisées

L'appareil est doté d'un buffer circulaire. Il est possible d'appeler les 16 dernières mesures.



Mettre en marche l'appareil



appuyez sur la touche pendant plus de 4 secondes, puis lâcher la touche pour accéder directement au menu de la mémoire



Faire défiler les articles



Répétition de l'article



Retour au mode de mesure

Affichage en format suivant (ligne par ligne en une séquence automatique, 3 secondes par ligne, jusqu'à l'affichage du dernier résultat):

Numéro d'ordre	n xx (xx: 16...1)
Année	YYYY (par exemple 2014)
Date	MM.dd (MoisMois.JourJour)
Heure	hh:mm (HeureHeure:MinuteMinute)
Méthode	Symbole de méthode
Résultat	x,xx

## Sélection menu

L'appareil est éteint

appuyer et maintenir enfoncé

appuyer brièvement et relâcher

relâcher



## Sélection menu

Appuyez sur la touche pour sélectionner l'option du menu (« Faire défiler »)

Sélection des points de menu suivants:

diS Lecture de données mémorisées

Prt Imprimer des données mémorisées

Réglage de la date et de l'heure

Réglage par l'utilisateur

Le point de menu sélectionné est indiqué par une flèche dans l'afficheur.



OU



Suivant la version de l'appareil

## diS – Lecture de données mémorisées

Sélection menu (voir « Sélection du menu »)

Faire défiler les articles

Répétition de l'article

Retour au mode de mesure

L'appareil est doté d'un buffer circulaire. Il est possible d'appeler les 16 dernières mesures.

Affichage en format suivant (ligne par ligne en une séquence automatique, 3 secondes par ligne, jusqu'à l'affichage du dernier résultat):

Número d'ordre	n xx (xx: 16...1)
Année	YYYY (par exemple 2014)
Date	MM.dd (MoisMois.JourJour)
Heure	hh:mm (HeureHeure:MinuteMinute)
Méthode	Symbole de méthode
Résultat	x,xx



Store Date  
▲ Prt  
Time Cal



**▲ Prt – Transmettre des données mémorisées  
- vers une imprimante ou un PC  
- pour le MD 100 et MD 200**

**ATTENTION:** Pour la transmission des données mémorisées vers une imprimante ou un PC, il faut disposer d'un module de transmission infrarouge de données (IRiM). Ceci peut être utilisé en association avec les appareils MD 100 et MD 200.

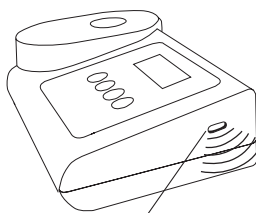
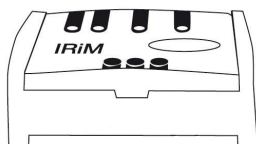

Encoche pour IR transmission de données

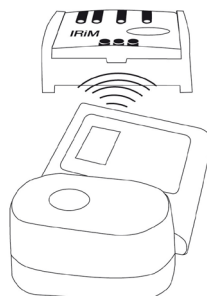

**PrtG**



Sélection menu (voir « Sélection du menu »)

Appuyez

L'IRiM et les appareils périphériques doivent être opérationnels. L'appareil affiche pendant 1 seconde environ «Prt» (impression)

Appuyez

Puis, il affiche le numéro du premier article de données et transmet les données. Tous les articles de données mémorisés sont transmis successivement. A la fin de la transmission, l'appareil passe au mode de mesure.

Une pression sur la touche [On/Off] permet d'arrêter la procédure de transmission. L'appareil s'éteint.



**E 162**

Dans le cas où la communication n'est possible avec aucun IRiM, un dépassement de délai d'attente [Time-out] intervient au terme de 2 minutes environ. L'appareil affiche le numéro d'erreur **E 132** pendant 4 secondes env., puis il rentre au mode de mesure normal (voir également le mode d'emploi de l'IRiM).

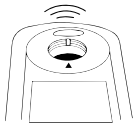

## **▲ Prt – Transmettre des données mémorisées - Bluetooth® - pour le MD 110**

Le MD 110 est équipé d'une interface Bluetooth® 4.0 qui permet le transfert sans fil des valeurs mesurées. Cette interface vous permet de transférer des valeurs déjà enregistrées. Le Bluetooth® 4.0 est aussi connu sous le nom de Bluetooth® Smart ou Bluetooth® LE (« Low energy » ou basse énergie). Les données sont transmises depuis le photomètre en format .csv. Vous pouvez télécharger la définition des informations transmises par le photomètre sur [www.lovibond.com](http://www.lovibond.com). Tintometer GmbH vous propose différentes solutions de réception des données.

L'app AquaLX® a été développée pour les terminaux mobiles. Elle traite les données reçues et en crée une analyse graphique. Les données et les graphiques peuvent être directement transférés par e-mail. Vous pouvez télécharger gratuitement AquaLX® dans l'iTunes Store® pour iOS® et dans le Google Play™ Store pour Android™.

Un outil logiciel permet de transférer sur PC les données enregistrées sur le photomètre. Les données peuvent être exportées en feuille de calcul Excel®, qui peut ensuite être utilisée comme outil d'analyse selon l'approche préférée par l'utilisateur. En l'absence d'Excel®, les données peuvent également être enregistrées en format .txt afin d'être analysées ultérieurement. Le dongle Bluetooth® livré avec le logiciel est nécessaire pour la réception des données.

Article	Référence de l'article
Logiciel, y compris le dongle Bluetooth®	2444480

Sélection menu (voir « Sélection du menu »)



Appuyez



Appuyez

Les appareils périphériques doivent être opérationnels.

L'appareil affiche l'état de la connexion Bluetooth®.

Le message suivant apparaît: „ncon“ (not connecting).

Une mise à jour du logiciel est peut être nécessaire pour avoir un mettre à jour des instruments reconnus. Voyez les instructions de AquaLX ou le logiciel de transfert de données pour le Bluetooth® Dongle.



In der Anzeige erscheint: „con“ (connecting).



Appuyez sur la touche [MODE] pour démarrer la transfert de données; pendant la transfert et la connexion «Prt» (impression) s'affiche sur l'écran.



Tous les articles de données mémorisés sont transmis successivement. Les résultats restent enregistrés dans le photomètre. A la fin de la



transmission, l'appareil passe au mode de mesure et la connexion Bluetooth® est interrompue.

Le transfert peut être annulé à tout moment en appuyant sur la touche [On/Off].



## **2 3** Réglage de la date et de l'heure (format 24 heures)

Sélection menu (voir « Sélection du menu »)



Appuyez 2x sur la touche = flèches dirigées vers Time & Date



confirmer



Augmenter la valeur



Réduire la valeur



Confirmez le réglage



Après la dernière confirmation, « IS SET » s'affiche à l'écran.

L'appareil retourne automatiquement au mode de mesure.

## Affichage de l'ajustage actuel

### Sélection menu (voir « Sélection du menu »)

3x = flèche dirigée sur Cal ou Cal à l'écran

confirmer

L'affichage est alternativement : CAL/„Methode“.



CAL

MÉTHODE

### Explication :

Réglage par l'utilisateur

Réglage à la fabrication

cAL

CAL



## 4 Réglage par l'utilisateur

Sélection menu (voir « Sélection du menu »)

3x = flèche dirigée sur Cal ou Cal à l'écran

confirmer

L'affichage est alternativement : CAL/„Methode“.



CAL

MÉTHODE



Sélectionner une méthode

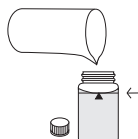

Remplissez une cuvette de 24 mm de 10 ml d'échantillon.

L'échantillon devrait être composé d'eau sans colorant et turbidité (par ex. eau purifiée, eau potable pure).

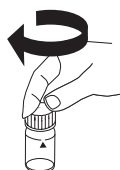

Fermez la cuvette.

## FR Réglage par l'utilisateur



Placez la cuvette réservée à l'échantillon dans la chambre de mesure. Attention à la positionner correctement.

Appuyez

⇒ MÉTHODE ⇐

Clignote pendant 8 secondes environ

0.0.0

CAL

La confirmation du calage du zéro 0.0.0 s'affiche en alternance avec CAL.

Zero  
Test

Effectuez la mesure avec un étalon de la concentration connue.

Appuyez

⇒ MÉTHODE ⇐

Clignote pendant 3 secondes environ

RÉSULTAT

CAL

Le résultat apparaît en alternance avec CAL.

Si le résultat est identique à la valeur de l'étalon utilisé (dans la tolérance à respecter), quittez le mode d'ajustage.

On  
Off

Appuyez

Si le résultat diffère de la valeur (en tenant compte de la tolérance), modifiez la valeur affichée :

Mode

1 x pression augmente le résultat affiché d'un chiffre.

Zero  
Test

1 x pression réduit le résultat affiché d'un chiffre.

Appuyer plusieurs fois sur les touches jusqu'à ce que le résultat affiché corresponde à la valeur du standard utilisé.

CAL

Le résultat apparaît en alternance avec CAL.

RÉSULTAT + x

appuyer sur la touche [!] pendant plus de 4 secondes

On  
Off

L'ajustage de l'application est terminé et sauvegardé.

### 4 Mode de réglage pour le fluorure

#### L'ajustement a lieu:

0 mg/l et 1 mg/l F standard et une cuvette propre  
(voir description de la méthode, Rem.)

#### Ajustage du fluorure :

##### Sélection menu (voir « Sélection du menu »)



3x = flèche dirigée sur Cal ou Cal à l'écran



confirmer

CAL

F

Après la confirmation de la sélection par une pression sur la touche [MODE], l'affichage affiche en alternance: CAL/F.

Verser 10 ml d'eau déminéralisée dans une cuvette propre de et fermer le couvercle de la cuvette.

Mettre la cuvette dans la chambre de mesure. Positionnement  $\Sigma$ .

Appuyer sur la touche [ZERO/TEST].



F

Le symbole de méthode clignote pendant 8 secondes environ.

0.0.0

La confirmation du calage du zéro 0.0.0 s'affiche en alternance avec CAL.

CAL

Ajouter **exactement 2 ml de solution réactive SPADNS** dans d'eau déminéralisée de 10 ml et fermer le couvercle de la cuvette et retourner plusieurs fois le couvercle pour mélanger son contenu.

Mettre la cuvette dans la chambre de mesure. Positionnement  $\Sigma$ .

Appuyer sur la touche [ZERO/TEST].



F

Le symbole de méthode clignote pendant 3 secondes environ.

FO

Le message suivant apparaît sur l'affichage:

Retirer la cuvette de la chambre de mesure, bien nettoyer la cuvette et le bouchon et remplir avec **exactement 10 ml de standard Fluorure (concentration 1 mg/l F)**.

Verser dans les 10 ml de standard Fluorure **exactement 2 ml de solution réactive SPADNS**. Bien refermer la cuvette avec son couvercle et mélanger le contenu en agitant légèrement.

Mettre la cuvette dans la chambre de mesure. Positionnement  $\Sigma$ .

Appuyer sur la touche [ZERO/TEST].



F



## FR Réglage par l'utilisateur

F1



: :

Le symbole de méthode clignote pendant 3 secondes environ.

Le message suivant apparaît sur l'affichage:

En appuyant sur la touche [ON/OFF], calculer le nouveau facteur de correction et le faire mémoriser au niveau réglage par l'utilisateur.

L'afficheur montre pendant 3 secondes la confirmation du réglage.

### Retour au réglage usine

Le retour du réglage utilisateur au réglage usine n'est possible que pour toutes les méthodes à la fois.

Pour une méthode qui a été réglée par l'utilisateur, une flèche est affichée à la position Cal lors de l'affichage du résultat à l'afficheur.

Procéder de la manière suivante pour remettre l'appareil au réglage usine:



appuyer et maintenir enfoncé en même temps

appuyer brièvement, relâcher

relâcher au bout d'une seconde environ

SEL

CAL

L'affichage montre en alternance:

Réglage à la fabrication

**ou:**

Réglage par l'utilisateur

SEL

cAL

Une pression active simultanément le réglage usine pour toutes les méthodes.

L'affichage montre en alternance:



SEL

CAL

Arrêter l'appareil





### Utilisation d'un kit étalon de référence (cf. également la page 63 Kits étalon de référence pour MD 100, MD 110 et MD 200)

Sur la base du mode d'emploi, sélectionner la méthode appropriée en tenant compte du système de réactifs utilisés (pastille, réactif liquide ou sachet de poudre Powder Pack). La mesure du réactif liquide s'effectue en mode de pastille.



Mettre en marche l'appareil.



Sélectionner méthodes.



Placez la cuvette Étalons de référence „Zéro“ dans la chambre de mesure. Attention à la positionner correctement.

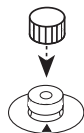

Mettre le capuchon en plastique souple..



Appuyer sur la touche [ZERO/TEST].

**0.0.0**

Confirmation du réglage du zéro



Retirez la cuvette de la chambre de mesure.



Réglez l'étalon de référence pour la méthode utilisée dans la chambre de mesure.  
Attention à la positionner correctement.



Appuyer sur la touche [ZERO/TEST].

**RÉSULTAT**

Le résultat de la mesure doit être comparé à la valeur indiquée dans le



certificat d'essai en tenant compte des tolérances (étalon & appareil). Tenir compte d'une affectation correcte aux systèmes de réactifs sélectionnés !

Si le résultat est hors des tolérances, vérifiez la date de péremption de l'étalon et que le photomètre a bien les ajustages du fabricant. Si tel est le cas, il est recommandé de retourner l'appareil au fabricant ou au distributeur.

### Étalons de référence pour MD 100, MD 110 et MD 200

Les étalons de référence servent uniquement à vérifier l'exactitude des photomètres figurant sur le certificat du test. Dans des conditions d'exploitation normales, le calibrage (ajustage) de ces appareils est stable à long terme. Le photomètre ne peut pas être ajusté avec les étalons de référence.

Les étalons de référence sont fournis dans des cuves bien fermées.

Les consignes de chaque étalon sont documentées dans un certificat. Les étalons de référence ont une durée de vie de deux ans à partir de la date de fabrication, sous réserve d'une utilisation et d'un stockage adéquats. Nettoyez toujours l'extérieur des cuves avec un chiffon propre avant de les utiliser.

Référence de l'article	Article	Plage de mesure
275650	<b>Kit chlore</b> pour appareils avec pastilles de réactifs/réactifs liquides	0,2* + 1,0* mg/l
275655	<b>Kit chlore</b> pour appareils avec pastilles de réactifs/réactifs liquides	0,5* + 2,0* mg/l
275656	<b>Kit chlore</b> pour appareils avec pastilles de réactifs/réactifs liquides	1,0* + 4,0* mg/l
275660	<b>Kit chlore</b> pour appareils avec pastilles/poudres de réactifs	0,2* + 1,0* mg/l
275670	<b>Kit pH</b> pour appareils avec pastilles de réactifs/réactifs liquides	7,45* pH

\* Valeur de référence, valeur exacte indiquée dans le certificat d'analyse.

### Utilisation d'un kit d'étalons de vérification (cf également kit d'étalons de vérification, page 66)



appuyer et maintenir enfoncé



appuyer brièvement et relâcher



relâcher

## FR Contrôle de l'appareil

Ab5

A530

Les valeurs suivantes s'affichent brièvement à l'écran :  
Ab5 suivi de la longueur d'onde à mesurer (par ex. A530 pour 530 nm).

Mode

Sur les appareils à plusieurs LED, sélectionnez la longueur d'onde désirée en pressant par ex. plusieurs fois la touche [Mode], (faire défiler).

Zero  
Test

Positionnez la cuve marquée « Zero » dans la chambre de mesure. Posez le capuchon et pressez la touche [Zero/Test].

longueurs d'onde

0.0.0

clignote pendant 3 secondes env.

Confirmation du réglage du zéro

Zero  
Test

Mettez plusieurs fois la cuve de la longueur d'onde sélectionnée à l'envers puis à l'endroit et déposez la dans la chambre de mesure.

longueurs d'onde

clignote pendant 3 secondes env.

### RÉSULTAT

Le résultat affiché est comparé à la valeur indiquée sur le certificat en tenant compte des tolérances (voir aussi les remarques du certificat).



Si le résultat est hors des tolérances et si la date de péremption des étalons n'est pas dépassée, il est recommandé de retourner l'appareil au fabricant ou au distributeur. Le fabricant vérifiera non seulement le calibrage de l'appareil mais aussi la présence de défauts techniques.

### Étalons de vérification

Les étalons de contrôle du MD 100 / MD 110 / MD 200 servent à vérifier l'exactitude de la détermination et la reproductibilité des résultats, basées sur les longueurs d'onde intégrées.

Le kit inclut une cuve zéro et 6 différentes cuves de mesure pour le contrôle de 6 différentes longueurs d'onde. Le kit d'étalons de vérification permet donc de vérifier tous les photomètres des séries MD 100 / MD 110 / MD 200.

Les étalons ont une durée de vie de deux ans à partir de la date de fabrication, sous réserve d'une utilisation et d'un stockage adéquats. Les mesures sont effectuées en unités de mAbs.

Référence de l'article	Article
21 56 70	Étalons de vérification

**Caractéristiques techniques MD 100,  
MD 110, MD 200**

Appareil	sélection automatique de la longueur d'onde, colorimètre à lecture directe
Système optiques	DEL, filtre d'interférences (IF) et détecteur optique à la chambre de mesure transparente Spécifications des longueurs d'ondes des filtres interfé- rentiels en fonction de la version de l'appareil, max. 3 longueurs d'onde possibles : 430 nm $\Delta\lambda = 5$ nm 530 nm $\Delta\lambda = 5$ nm 560 nm $\Delta\lambda = 5$ nm 580 nm $\Delta\lambda = 5$ nm 610 nm $\Delta\lambda = 6$ nm 660 nm $\Delta\lambda = 5$ nm
Plage photométrique	-2600 - 2600 mAbs
Précision de longueur d'onde	$\pm 1$ nm
Précision photométrique*	3 % FS (T = 20 °C – 25 °C)
Résolution photométrique	0,01 A
Auto-OFF	arrêt automatique de l'appareil 10 ou 25 minutes après le dernier appui sur une touche (Différents temps de réaction suivant la méthode disponi- ble)
Affichage	Ecran à cristaux liquides à éclairage par le fond (sur pression sur une touche)
Heure	Horloge à temps réel et date
Réglage	Réglage usine et réglage utilisateur. Le retour du réglage usine est possible à tout moment.
Conditions ambiantes	température: 5–40°C 30–90% d'humidité relative de l'air (sans condensation)
Étanche à l'eau	flottable ; IP 68 analogique (1 heure à 0,1 m)
CE	Certificat de déclaration de conformité européenne voir <a href="http://www.lovibond.com">www.lovibond.com</a>

*\*mesure effectuée au moyen de solutions standard*



La précision spécifique des appareils n'est garantie que pour une utilisation des réactifs originaux joints par le fabriquant.

**Caractéristiques techniques MD 100**

Alimentation électrique	4 piles (AAA/LR 03)
Durée de fonctionnement	17 heures de fonctionnement ou 5000 mesures en utilisation permanente, si le rétro-éclairage ne sont pas active
Mémoire	Mémoire circulaire interne pour 16 articles de données
Interface	interface IR pour transfert de données
Dimensions	155 x 75 x 35 mm (L x l x H)
Poids	Appareil de base 260 g environ (avec piles)



**Caractéristiques techniques MD 110**

Alimentation électrique	4 piles (AAA/LR 03)
Durée de fonctionnement	17 heures de fonctionnement ou 5000 mesures en utilisation permanente, si le rétro-éclairage et le transfert des données par Bluetooth® ne sont pas active.
Mémoire	Mémoire circulaire interne pour 125 articles de données
Interface	Bluetooth® 4.0 pour le transfert de données de mesure stockées
Module Bluetooth® :	Spécifications: Modul: BLE113-A Bluetooth® 4.0 LE FCC ID: QOQBT113 IC: 5123A-BGTBLE113
Dimensions	155 x 75 x 35 mm (L x l x H)
Poids	Appareil de base 260 g environ (avec piles)

**Caractéristiques techniques MD 200**

Alimentation électrique	4 piles (Mignon AA/LR 6)
Durée de fonctionnement	53 heures de fonctionnement ou 15000 mesures en utilisation permanente en désactivant le rétro-éclairage
Mémoire	Mémoire circulaire interne pour 16 articles de données
Interface	interface IR pour transfert de données
Dimensions	190 x 110 x 55 mm (L x l x H)
Poids	Appareil de base 455 g environ (avec piles)

## Informations à l'utilisateur

<b>Hi</b>	Plage de mesure dépassée ou turbidité trop élevée.
<b>Lo</b>	Plage de mesure pas atteinte.
	Remplacer immédiatement les piles, impossible de continuer à travailler.
<b>btLo</b>	Tension des piles insuffisante pour le rétro-éclairage du display. Mesure toutefois possible.
	Pour une méthode qui a été réglée par l'utilisateur, une flèche est affichée à la position Cal lors de l'affichage du résultat à l'afficheur (voir «Retour au réglage usine»).

## Messages d'erreur

<b>E27 / E28 / E29</b>	Absorption de lumière trop élevée. Cause par exemple: système optique encrassé.
<b>E 10 / E 11</b>	Facteur de réglage en dehors de la plage autorisée.
<b>E 20 / E 21</b>	Le détecteur reçoit trop de lumière.
<b>E23 / E24 / E25</b>	Le détecteur reçoit trop de lumière.
<b>E 22</b>	La pile était trop faible pendant la mesure. Changer la pile.
<b>E 70</b>	Ces messages de défaut signalent une erreur d'ajustage ou un manque d'ajustage côté fabricant ou utilisateur. Veuillez contacter notre service technique à l'adresse <a href="mailto:techsupport@tintometer.de">techsupport@tintometer.de</a> .
<b>E 71</b>	
<b>E 72</b>	
<b>:</b>	

• <b>Informazioni importanti</b> .....	73
• <b>Indicazioni generali</b> .....	74
Indicazioni tecniche operative .....	74
Indicazioni relative ai metodi .....	74
Applicazione dell'anello di chiusura a tenuta .....	75
Applicazione del cappuccio .....	75
Posizionamento dell'adattatore .....	75
Posizionamento delle cuvette .....	75
Corretto riempimento della cuvetta .....	75
Corretta manipolazione dei reagenti .....	75
Sostituzione della batteria .....	76
• <b>Descrizione funzionale</b> .....	77
Funzionamento .....	77
Scroll Memory (SM) .....	77
Esecuzione di un azzeramento .....	77
Svolgimento della misurazione .....	78
OTZ (One Time Zero) .....	78
Retroilluminazione del display .....	78
Funzione Countdown / Tempo di reazione .....	79
Lettura dei dati memorizzati .....	79
• <b>Menù opzioni</b> .....	80
Richiamo menu .....	80
Selezione menù .....	80
Lettura dei dati memorizzati .....	80
Trasmissione dei dati memorizzati - alla stampante o al PC - al MD 100 e MD 200 ..	81
Trasmissione dei dati memorizzati – Bluetooth® - al MD 110 .....	82
Impostazione di data e ora (formato 24h) .....	83
• <b>Regolazione dell'utente</b> .....	84
Visualizzazione dell'ultima impostazione di regolazione .....	84
Regolazione dell'utente .....	84
Modalità di regolazione per il fluoruro .....	86
Ripristino della regolazione del produttore .....	87
• <b>Controllo dell'apparecchio</b> .....	88
Utilizzo di un kit standard di riferimento .....	88
Utilizzo di un kit standard di verifica .....	89
• <b>Dati tecnici</b> .....	91
• <b>Indicazioni per l'utente</b> .....	93
• <b>Messaggi di errore</b> .....	93



## Informazioni importanti per i consumatori nell'UE

### Indicazioni sullo smaltimento di pile e accumulatori



In base alla normativa concernente le batterie (Direttiva 2006/66/CE) ogni consumatore è tenuto per legge alla restituzione di tutte le batterie o accumulatori usati ed esauriti. È vietato lo smaltimento con i rifiuti domestici. Dato che anche alcuni prodotti del nostro assortimento sono provvisti di pile e accumulatori, vi diamo di seguito delle indicazioni : Pile e accumulatori esauriti non vanno smaltiti insieme ai rifiuti domestici, ma depositati gratuitamente nei punti di raccolta del proprio comune o nei punti vendita di pile e accumulatori dello stesso tipo. Inoltre il consumatore finale può portare batterie e accumulatori al rivenditore presso il quale li ha acquistati (obbligo di raccolta previsto per legge).

### Smaltimento di apparecchiature elettriche



In base alla Direttiva europea 2012/19/UE, gli apparecchi elettrici non devono essere smaltiti insieme ai normali rifiuti domestici! Noi provvederemo a smaltire i vostri apparecchi elettrici in maniera professionale e responsabile verso l'ambiente. Questo servizio, escluso il trasporto, è completamente gratuito. Il servizio si applica agli apparecchi elettrici acquistati successivamente al 13 agosto 2005. Si prega di inviare il apparecchio elettrico Tintometer divenuti inutilizzabili a trasporto pagato al vostro rivenditore.

## Sicurezza - Avvertenze generali

Il produttore declina ogni responsabilità e non fornisce alcuna garanzia per danni connessi e conseguenti all'uso improprio, alla mancata osservanza delle presenti Istruzioni d'uso, all'impiego di personale specializzato non adeguatamente qualificato e ad eventuali modifiche apportate in proprio all'apparecchio. Il produttore non risponde di costi o danni che possono insorgere per l'utente o terzi in seguito all'impiego del presente apparecchio, in particolare in caso di utilizzo scorretto dell'apparecchio o di uso improprio o guasti al collegamento o all'apparecchio stesso. Il produttore non si assume alcuna responsabilità per errori di stampa.

## Informazioni sulla sicurezza contenute nelle presenti Istruzioni d'uso

Le presenti Istruzioni d'uso contengono informazioni importanti per l'utilizzo sicuro del prodotto. Leggere attentamente le presenti istruzioni e acquisire familiarità con il prodotto prima di metterlo in funzione o di lavorare con esso. Tenere sempre il presente manuale a portata di mano, per poterlo consultare all'occorrenza.



### Nota:

La descrizione dei metodi e la manipolazione dei reagenti non fanno parte di questo manuale. I file possono essere trovati sul supporto dati allegato o possono essere scaricati dal nostro sito Web.

## Indicazioni tecniche operative

1. Le cuvette, i coperchi e la bacchetta devono essere pulite accuratamente **in seguito ad ogni analisi**, per evitare errori di misurazione. Anche piccoli residui di reagenti possono determinare misurazioni errate.
2. Le pareti esterne o le cuvette devono essere pulite ed asciugate prima di iniziare l'analisi. Eventuali impronte delle dita o gocce d'acqua sulla superficie di penetrazione della luce della cuvetta portano a misurazioni errate.
3. Taratura a zero e test devono essere effettuati con la stessa cuvetta, poiché le cuvette possono mostrare tolleranze minime diverse fra loro.
4. Per l'azzeramento ed il test la cuvetta deve essere sempre posta nel pozzetto di misurazione in modo tale che la gradazione con il triangolo bianco indichi sempre la tacca sull'esterno.
5. L'azzeramento ed il test devono essere eseguiti con il coperchio della cuvetta chiuso. Il coperchio della cuvetta deve essere provvisto di anello di tenuta.
6. La formazione di bollicine nelle pareti interne della cuvetta può condurre a misurazioni errate. In tal caso la cuvetta viene chiusa con l'apposito coperchio e le bollicine vanno sciolte agitando la cuvetta stessa prima dell'esecuzione del test.
7. E' necessario evitare la penetrazione di acqua nel pozzetto di misurazione per non avere una rottura delle componenti elettroniche ed evitare così risultati errati.
8. Eventuali impurità presenti nel pozzetto trasparente possono essere causa di misurazioni errate. Le superfici di penetrazione della luce del pozzetto trasparente devono essere controllate ed eventualmente pulite ad intervalli regolari. Per la pulizia utilizzare panni umidi che non lasciano pelucchi (privi di olio) e bastoncini di ovatta.
9. Eventuali differenze di temperatura evidenti fra il fotometro e l'ambiente circostante possono comportare misurazioni errate, per es. a causa della formazione di acqua di condensa nel pozzetto di misurazione e nella cuvetta.
10. Proteggere l'apparecchio dalla luce diretta dei raggi solari durante il funzionamento.
11. I reagenti in compresse devono essere introdotti direttamente nella pellicola, evitando il contatto con le dita.
12. E' assolutamente necessario rispettare la sequenza di introduzione delle compresse.

## Indicazioni relative ai metodi

- Possibilità di utilizzo, osservare le indicazioni per l'analisi e gli effetti matrice dei metodi.
- Vari ricariche disponibili a richiesta.
- I reagenti sono concepiti per l'analisi chimica, e devono essere conservati fuori dalla portata dei bambini.
- Provvedere al regolare smaltimento delle soluzioni dei reagenti
- Se necessario, richiedere i fogli dei dati di sicurezza.  
(Internet: [www.lovibond.com](http://www.lovibond.com))

## IT Indicazioni generali

**Applicazione dell'anello di chiusura a tenuta:**

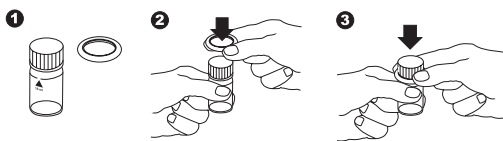

**Applicazione del cappuccio:**

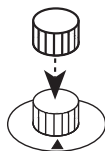

**Posizionamento dell'adattatore:**

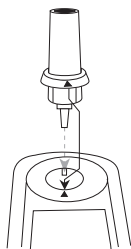

**Posizionamento delle cuvette:**

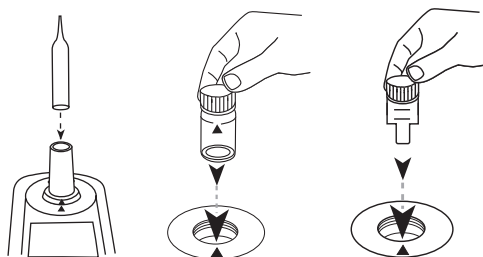

**Corretto riempimento della cuvetta:**

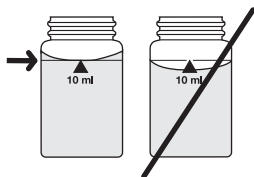

**Corretta manipolazione dei reagenti:**

**Bustina di polvere**

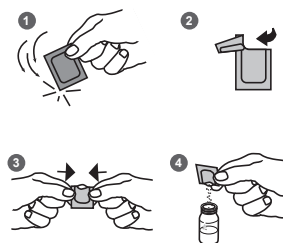

**Reagenti liquidi**



**Compresse in blister**

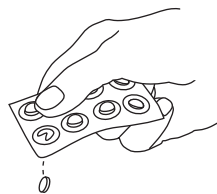

## Sostituzione della batteria

### MD 100 / MD 110

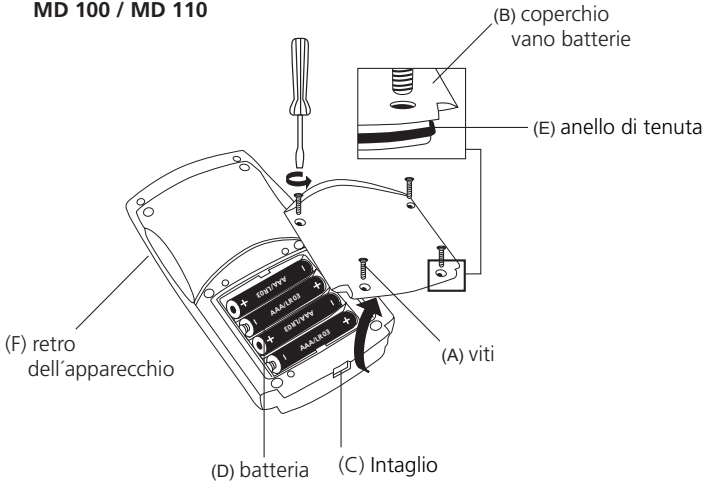

### MD 200

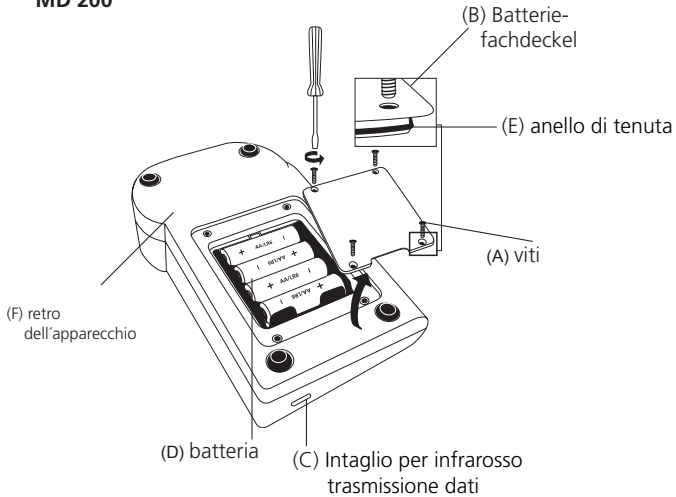

### ATTENZIONE:

**Per poter garantire la completa ermeticità del fotometro, inserire l'anello di tenuta (E) ed avvitare il coperchio del vano batterie (B).**

Se la batteria viene rimossa dallo strumento per oltre 1 minuto, con la nuova alimentazione di energia (inserimento della nuova batteria), all'accensione dello strumento, appare automaticamente il programma di data e ora.

### Funzionamento



Accendere l'apparecchio



Scelta del metodo



#### Scroll Memory (SM)

Negli strumenti multiparametro la sequenza dei vari metodi è predefinita. Una volta acceso lo strumento, viene automaticamente visualizzato il metodo selezionato per ultimo prima dello spegnimento. Ciò consente di accedere rapidamente ai metodi preferiti.



#### Avviso:

La descrizione dei metodi e la manipolazione dei reagenti non fanno parte di questo manuale ma sono contenuti in un documento separato.



#### Metodo per fluoruro

##### Attenzione:

Con la prima attivazione è necessario di effettuare un adatto del metodo (vedi "Selezione menù": ▼ Modalità di regolazione per il fluoruro). Per la regolazione e la misurazione del campione è necessario impiegare lo stesso batch di soluzione del reagente SPADNS. Regolare lo strumento per ogni nuovo batch di soluzione del reagente SPADNS.

### Esecuzione di un azzeramento



Riempire una cuvetta da 24 mm con 10 ml di campione.

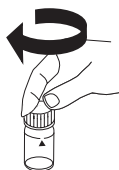

Chiudere la cuvetta.



Posizionare la cuvetta del campione nel vano di misurazione. Fare attenzione al posizionamento.

## IT Descrizione funzionale



Premere il tasto [ZERO/TEST].



Prelevare la cuvetta dal vano di misurazione.

### OTZ (One Time Zero)

L'One Time Zero è disponibile per tutti i tipi di fotometri in cui l'azzeramento avviene in una cuvetta rotonda da 24 mm con acqua campione. Può essere utilizzato se vengono eseguiti diversi test in presenza di condizioni di prova identiche con il medesimo campione d'acqua. In caso di cambio metodo, non è più necessario eseguire una nuova regolazione dello zero, bensì è possibile iniziare direttamente con il test. L'azzeramento viene memorizzato fino allo spegnimento del dispositivo.

Sarà comunque possibile procedere con la taratura a zero ogni qualvolta lo si ritenga necessario.



One Time Zero (OTZ), 1x esecuzione di un azzeramento, quindi misurazione dei parametri



Nuova taratura a zero, premere il tasto ZERO per 2 secondi.

### Svolgimento della misurazione



Aggiungere il reagente (per esempio una compressa) (vedi descrizione dei metodi)



Chiudere la cuvetta.

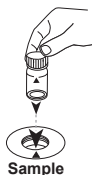

Posizionare la cuvetta del campione nel vano di misurazione. Fare attenzione al posizionamento.



Premere il tasto [ZERO/TEST].

### Retroilluminazione del display



Premere, durante la misurazione la retroilluminazione si disattiva automaticamente.

### Funzione Countdown / Tempo di reazione

Per i metodi con tempo di reazione, è possibile attivare una funzione Countdown per alcuni metodi durante la procedura di test. premere e tenere premuto



premere



lasciare

Il Countdown / il tempo di reazione scorre, la misurazione avviene automaticamente con il trascorrere del tempo.



Interrompere il Countdown / Tempo di reazione



#### Attenzione:

**se non mantenete il tempo di reazione i risultati forse saranno errati.**

#### Avviso:

La descrizione dei metodi e la manipolazione dei reagenti non fanno parte di questo manuale ma sono contenuti in un documento separato.



### Letture dei dati memorizzati

L'apparecchio dispone di una memoria circolare. È possibile richiamare gli ultimi 16 valori di misura.



Accendere l'apparecchio



Tenere premuto per almeno 4 secondi, dann loslassen, per passare direttamente al menù di memorizzazione.



Scorsa tra i data set



Ripetizione del data set



Ritorno alla modalità di misurazione

Visualizzazione nel formato seguente (riga per riga in sequenza automatica, 3 secondi per riga, fino alla visualizzazione del risultato):

n. prog.	n xx (xx: 16..1)
Anno	YYYY (es. 2014)
Data	MM.dd (MeseMese.GiornoGiorno)
Ora	hh:mm (OraOra:MinutoMinuto)
Metodo	Simbolo del metodo
Risultato	x,xx

## Richiamo menu

Il dispositivo è spento



premere e **tenere premuto**

premere brevemente poi lasciare

lasciare

## Selezione menù

Premere per selezionare la voce di menu (scorrere)



oder



Secondo la versione dell'apparecchio

Selezionare dal menù le seguenti voci:

▲ diS Lettura dei dati memorizzati

▲ Prt Stampa dei dati memorizzati

▲ ▾ Impostazione di data e ora

▾ Regolazione dell'utente

La voce selezionata viene visualizzata sul display con una freccia.

## ▲ diS – Lettura dei dati memorizzati



Richiamo menu (vedi "Richiamo menu")

Scorsa tra i data set



Ripetizione del data set



Ritorno alla modalità di misurazione



L'apparecchio dispone di una memoria circolare. È possibile richiamare gli ultimi 16 valori di misura.

Visualizzazione nel formato seguente (riga per riga in sequenza automatica, 3 secondi per riga, fino alla visualizzazione del risultato):

n. prog.	n xx (xx: 16...1)
Anno	YYYY (es. 2014)
Data	MM.dd (MeseMese.GiornoGiorno)
Ora	hh:mm (OraOra:MinutoMinuto)
Metodo	Simbolo del metodo
Risultato	x,xx



Store Date  
▲ Prt  
Time Cal



## ▲ Prt – Trasmissione dei dati memorizzati - alla stampante o al PC - al MD 100 e MD 200

**ATTENZIONE:** Per la trasmissione dei dati memorizzati ad una stampante o ad un PC è necessario un modulo di trasferimento dati (IRiM), disponibile come optional. Questo può essere usato in combinazione con gli apparecchi MD 100 e MD 200.

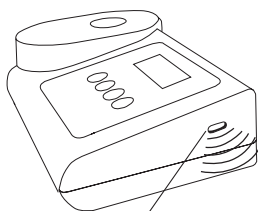
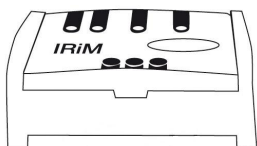

Intaglio per infrarosso  
trasmissione dati

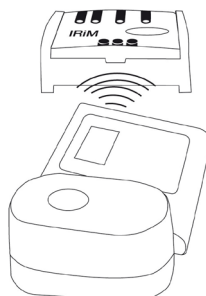

**PrtG**

**Mode**

Richiamo menu (vedi "Richiamo menu")

premere

L'IRiM e le periferiche devono essere predisposti pronti all'uso. Lo strumento mostra per ca. 1 secondo "PrtG" (Printing)

premere

Quindi, viene visualizzato il numero della prima serie di dati ed i dati vengono trasferiti. Una dopo l'altra, vengono trasmesse tutte le serie di dati memorizzati. Al termine lo strumento passa alla modalità di misurazione.

**On**  
**Off**



**E 162**

Il processo di stampa può essere interrotto premendo il tasto [On/Off]. Lo strumento si spegne.

Se la comunicazione con un IrIM è impossibile, dopo ca. 2 minuti si verifica un timeout. Per ca. 4 secondi viene visualizzato il codice di errore **E 162**, dopodiché lo strumento torna alla normale modalità di misurazione (vedi anche le istruzioni dell'IRiM).

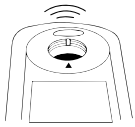

**▲ Prt – Trasmissione dei dati memorizzati  
– Bluetooth® - al MD 110**

L'MD 110 ha un'interfaccia bluetooth® 4.0, che consente la trasmissione wireless dei risultati di misurazione. Qui vengono trasmessi i risultati archiviati. Bluetooth® 4.0 è anche conosciuto come Bluetooth® Smart o Bluetooth® LE (a basso consumo energetico). I dati vengono trasferiti dal fotometro in formato .csv. Una definizione delle informazioni trasmesse dal fotometro può essere scaricata da [www.lovibond.com](http://www.lovibond.com). Per la ricezione dei dati, Tintometer GmbH offre diverse soluzioni.

Per i dispositivi mobili è disponibile l'applicazione AquaLX®, che gestisce i dati ricevuti e li analizza graficamente. Sia i dati che i grafici possono essere inviati direttamente via e-mail. AquaLX® può essere scaricata gratuitamente da iTunes Store® per iOS® e dal Googl Play™ Store di Android™.

Uno strumento software permette la ricezione dei dati memorizzati sul fotometro su un PC. I dati possono essere esportati in un foglio Excel®, che può essere utilizzato direttamente come strumento di valutazione per l'utente nel modo consueto. Se nessun Excel® è disponibile, in alternativa i dati possono essere salvati come file .txt, pronti per la successiva valutazione. Nella confezione del software è incluso un adattatore Bluetooth® necessario per ricevere i dati.

Articolo	N. articolo
Software, incluso il dongle Bluetooth®	2444480

Richiamo menu (vedi "Richiamo menu ")



premere



premere

Le periferiche devono essere predisposti pronti all'uso.

Il display visualizza lo stato della connessione Bluetooth®.



Nel display appare: „ncon“ (not connecting).

Potrebbe essere necessario aggiornare l'elenco dei dispositivi rilevati nel software sul strumento, vedere le istruzioni del AquaLX o del software per trasferimento dati per il dongle Bluetooth®.



Nel display appare: „con“ (connecting).



Premendo il tasto [MODE] viene avviata la trasmissione dei dati; durante la connessione ed il trasferimento dei dati lo strumento mostra "PtrG" (Printing).

Una dopo l'altra, vengono trasmesse tutte le serie di dati memorizzati. I valori di misura rimangono memorizzati sul fotometro.

Al termine lo strumento passa alla modalità di misurazione e la connessione bluetooth® viene interrotta.



La trasmissione può essere interrotto in qualsiasi momento premendo il tasto [On/Off]. Lo strumento si spegne.



### Impostazione di data e ora (formato 24h)

Richiamo menu (vedi "Richiamo menu")



Pressione 2x = simboli freccia su Time & Date



confermare



Aumento del valore



Riduzione del valore



Conferma dell'impostazione



Sul display compare "IS SET" dopo l'ultima conferma.

Lo strumento torna automaticamente nella modalità di misurazione.

### Visualizzazione dell'ultima impostazione di regolazione

#### Richiamo menu (vedi "Richiamo menu")

3x = simboli freccia su Cal e Cal sul display

confermare

Sul display compare a intermittenza: CAL/"Metodo".



CAL

METODO

cAL

CAL

#### Spiegazione:

Regolazione dell'utente

Regolazione del produttore



### 4 Regolazione dell'utente

Richiamo menu (vedi "Richiamo menu")

3x = simboli freccia su Cal e Cal sul display

confermare

Sul display compare a intermittenza: CAL/"Metodo".



CAL

METODO



Scelta del metodo



24-mm-Küvette mit 10 ml Probe füllen

Il campione deve essere costituito da acqua incolore e non torbida (ad esempio acqua deionizzata, acqua potabile pura).

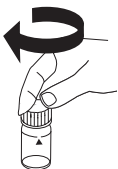

Chiudere la cuvetta.

## IT Regolazione dell'utente



Posizionare la cuvetta nel vano di misurazione.  
Fare attenzione al posizionamento.

premere

METODO

lampeggia per ca. 8 secondi

0.0.0

La conferma dell'azzeramento 0.0.0. appare in alternanza a CAL.

CAL

Eeguire la misurazione con uno standard di concentrazione.

Zero  
Test

premere

METODO

lampeggia per ca. 3 secondi

RISULTATO

Il risultato appare alternato con CAL.

CAL

Se il risultato corrisponde con il valore dello standard utilizzato (nell'ambito della tolleranza da tenere in considerazione) la modalità di regolazione viene abbandonata premendo il tasto [ON/OFF].

On  
Off

premere

Se il risultato si colloca al di fuori del valore (in considerazione della tolleranza), modificare il valore visualizzato:

Mode

1 x premere, il risultato visualizzato aumenta di 1 digit.

Zero  
Test

1 x premere, il risultato visualizzato si riduce di 1 digit

Premere ripetutamente i tasti finché non appare il risultato visualizzato dello standard utilizzato.

CAL

Il risultato appare alternato con CAL.

RISULTATO + x

tenere premuto per almeno 4 secondi

On  
Off

La calibrazione dell'applicazione è conclusa e salvata.

#### 4 Modalità di regolazione per il fluoruro

**La registrazione avviene inoltre:**

0 mg/l e 1 mg/l F Standard e una cuvetta pulita

(vedi descrizione dei metodi, Annotazioni)

#### Regolazione del fluoruro:

Richiamo menu (vedi "Richiamo menu")



3x = simboli freccia su Cal e Cal sul display



confermare

CAL

Dopo aver confermato la selezione con il tasto [MODE], sul display appare alternato: CAL/F.

F

In una cuvetta pulita da 24 mm introdurre esattamente 10 ml di acqua completamente desalinizzata e chiudere con l'apposito coperchio.

Porre la cuvetta nel pozzetto di misurazione. Posizione  $\Sigma$ .

Zero  
Test

Premere il tasto [ZERO/TEST].

F

Il simbolo del metodo lampeggia per ca. 8 secondi.

0.0.0

La conferma della taratura a zero 0.0.0 appare alternato con CAL.

CAL

Introdurre nei 10 ml di acqua completamente desalinizzata **esattamente 2 ml di soluzione reagente SPADNS**. Chiudere la cuvetta con l'apposito coperchio e mescolare il contenuto capovolgendo la cuvetta stessa.

Porre la cuvetta nel pozzetto di misurazione. Posizione  $\Sigma$ .

Zero  
Test

Premere il tasto [ZERO/TEST].

F

Il simbolo del metodo lampeggia per ca. 3 secondi.

F0

Nel display appare:

Estrarre la cuvetta dal pozzetto di misurazione. Pulire accuratamente la cuvetta ed il coperchio e riempirla con **10 ml di fluoruro standard (concentrazione 1 mg/l F) precisi**.

Aggiungere ai 10 ml di fluoruro standard esattamente **2 ml di soluzione reagente SPADNS**. Chiudere bene la cuvetta con l'apposito tappo e mescolare il contenuto capovolgendolo.

Porre la cuvetta nel pozzetto di misurazione. Posizione  $\Sigma$ .

Zero  
Test

Premere il tasto [ZERO/TEST].

F

Il simbolo del metodo lampeggia per ca. 3 secondi.

## IT Regolazione dell'utente

F1



: :

Nel display appare:

Premendo il tasto [ON/OFF] il nuovo fattore di correzione viene calcolato e memorizzato nel livello di regolazione dell'utente.

Nel display appare per 3 secondi la conferma della regolazione.



### Ripristino della regolazione del produttore

Il ripristino della regolazione del produttore è possibile solo per tutti i metodi contemporaneamente.

Quando il metodo è stato regolato dall'utente, con il risultato sul display viene visualizzata una freccia nella posizione Cal.

Per ripristinare la regolazione del produttore procedere come segue:



premere e **tenere premuti** insieme

premere brevemente poi lasciare

Dopo ca. 1 secondo lasciare i tasti [MODE] e [ZERO/TEST].

Nel display appare alternato:

SEL

CAL

Regolazione del produttore

**oder:**

SEL

cAL

Regolazione dell'utente

Mode

SEL

CAL

Premendo il tasto viene attivata la regolazione del produttore per tutti i metodi contemporaneamente.

Nel display appare alternato:

On/Off

Lo strumento viene acceso con il tasto.

## IT Controllo dell'apparecchio



### Utilizzo di un kit standard di riferimento (vedere anche pagina 85 Kit standard di riferimento per MD 100, MD 110 e MD 200)

Scegliere il metodo corrispondente in conformità alle istruzioni d'uso tenendo in considerazione il sistema di reazione utilizzato (compressa, reagente liquido o Powder Pack). Il reagente liquido viene misurato nella modalità della compressa.



Accendere l'apparecchio.



Scelta del metodo.



Posizionare la cuvetta **Standard di riferimento „Zero“** nel vano di misurazione. Fare attenzione al posizionamento.

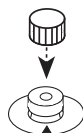

Avviare l'apparecchio.



Premere il tasto [ZERO/TEST].

**0.0.0**

Conferma dell'azzeramento

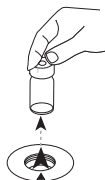

Prelevare la cuvetta dal vano di misurazione.



### Impostare lo standard di riferimento per il metodo corrispondente nel pozzetto di misurazione.

Fare attenzione al posizionamento.



Premere il tasto [ZERO/TEST].

**RISULTATO**

Il risultato è comparato con il valore documentato certificato del test, tenendo in considerazione le tolleranze (standard e strumento).





Rispettare la corretta associazione ai sistemi di reazione prescelti!

Se il risultato è fuori tolleranza, controllare la durabilità degli standard e verificare che il fotometro sia allineato alle impostazioni di fabbrica. In caso affermativo, si consiglia di restituire l'apparecchio al produttore o al rivenditore.

### Standard di riferimento per MD 100, MD 110 e MD 200

Gli standard di riferimento sono utilizzati esclusivamente per verificare l'accuratezza della misurazione dei fotometri elencati nel certificato di prova. La calibrazione (regolazione) di questi dispositivi è stabile a lungo termine in condizioni di lavoro normali. Il fotometro non può essere regolato con gli standard di riferimento.

Gli standard di riferimento sono forniti in cuvette ermeticamente sigillate.

I setpoint per ciascuno standard sono documentati nel certificato. La durata di conservazione degli standard di riferimento è di due anni dalla data di produzione se utilizzati e conservati correttamente. Pulire sempre le cuvette dall'esterno con un panno pulito prima dell'utilizzo.

N. articolo	Articolo	Campo di misuraz.
275650	<b>Kit cloro</b> per apparecchi con reagenti a compressa/liquidi	0,2* + 1,0* mg/l
275655	<b>Kit cloro</b> per apparecchi con reagenti a compressa/liquidi	0,5* + 2,0* mg/l
275656	<b>Kit cloro</b> per apparecchi con reagenti a compressa/liquidi	1,0* + 4,0* mg/l
275660	<b>Kit cloro</b> per apparecchi con reagenti in compresse/polvere	0,2* + 1,0* mg/l
275670	<b>Kit pH</b> per apparecchi con reagenti a compressa/liquidi	7,45* pH

\* Valore di riferimento, valore preciso secondo il certificato di analisi.

### Utilizzo di un kit standard di verifica (vedi anche Kit standard di verifica, pagina 88)



premere e **tenere premuti** insieme



premere brevemente poi lasciare



lasciare.

## IT Controllo dell'apparecchio

**AbS**

A530

Sul display compare brevemente:

AbS seguito dalla lunghezza d'onda da misurare (ad es. A530 per 530 nm)

**Mode**

Per quanto riguarda gli apparecchi con diversi LED, selezionare (scorrere) la lunghezza d'onda desiderata eventualmente premendo più volte il pulsante [Mode].

**Zero  
Test**

Posizionare la cuvetta contrassegnata da "Zero" nel pozzetto di misurazione. Applicare il cappuccio e premere il pulsante [Zero/Test].

lunghezze d'onda

lampeggia per ca. 3 secondi

**0.0.0**

Conferma dell'azzeramento

**Zero  
Test**

Rovesciare più volte la cuvetta con la lunghezza d'onda selezionata e posizionarla nel pozzetto di misurazione. Abdeckkappe aufsetzen e premere [Zero/Test].

lunghezze d'onda

lampeggia per ca. 3 secondi

**RISULTATO**

Confrontare il risultato visualizzato con il valore stampato nel certificato tenendo conto delle tolleranze (vedere anche le note nel certificato).



Se il risultato è al di fuori della tolleranza e gli standard sono entro la durabilità, si consiglia di restituire l'apparecchio al produttore o al rivenditore. La revisione da parte del produttore è opportuna dal momento che l'apparecchio viene testato onde verificare la presenza di difetti tecnici oltre ad essere calibrato.

### Standard di verifica

Gli standard di verifica per MD 100 / MD 110 / MD 200 vengono utilizzati per verificare l'accuratezza e la riproducibilità dei risultati delle misurazioni, in base alle lunghezze d'onda integrate.

Il kit include una cuvetta zero e 6 diverse cuvette per testare 6 diverse lunghezze d'onda. Il kit standard di verifica consente quindi la revisione di tutti i fotometri della serie MD 100 / MD 110 / MD 200.

La durabilità degli standard è di due anni dalla data di produzione, se utilizzati e conservati correttamente. Le misurazioni avvengono in unità di mAbs.

N. articolo	Articolo
21 56 70	Standard di verifica MD 100 / MD 110 / MD 200

**Dati tecnici MD 100, MD 110, MD 200**

Strumento	selezione automatica della lunghezza d'onda, colorimetro con lettura diretta
Gruppo ottico	LED, filtro di interferenza (IF) ed il fotosensore sul pozzetto di misurazione trasparente Specifiche della lunghezza d'onda dei filtri d'interferenza in base alla versione dell'apparecchio, max. 3 lunghezze d'onda possibili lunghezze d'onda integrate: 430 nm $\Delta \lambda = 5$ nm 530 nm $\Delta \lambda = 5$ nm 560 nm $\Delta \lambda = 5$ nm 580 nm $\Delta \lambda = 5$ nm 610 nm $\Delta \lambda = 6$ nm 660 nm $\Delta \lambda = 5$ nm
Intervallo fotometrico	-2600 - 2600 mAbs
Correttezza lunghezza d'onda	$\pm 1$ nm
Precisione fotometrica*	3 % FS (T = 20 °C – 25 °C)
Risoluzione fotometrica	0,01 A
Spegnimento automatico	Spegnimento automatico dello strumento 10 rispettivamente 20 minuti dopo l'ultimo azionamento di un tasto (diversi tempi di reazione a seconda del metodo disponibile)
Display	LCD retroilluminato (alla pressione di un tasto)
Ora	Ora effettiva e data
Regolazione	regolazione dell'utente Il ripristino della regolazione del produttore è possibile in ogni tempo.
Condizioni ambientali	temperatura: 5–40°C 30–90% umidità rel. (senza condensa)
a chiusura ermetica	galleggiabile; come IP 68 (1 ora a 0,1 m)
CE	Certificato di dichiarazione di conformità CE vedi <a href="http://www.lovibond.com">www.lovibond.com</a>

*\*misurata con soluzioni standard*



La precisione del sistema specificata è garantita solo con l'uso di ns. reagenti originali.

**Dati tecnici MD 100**

Batteria	4 microbatterie (AAA/LR 03)
Tempo di funzionamento	17h aziendale periodo rispettivamente 5000 misurazioni nella prova costante disattivare la retroilluminazione
Memoria	Memoria circolare interna per 16 serie di dati
Interfaccia	Interfaccia IR per la trasmissione dei dati di misurazione
Dimensioni	155 x 75 x 35 mm (l x l x a)
Peso	Apparecchio base ca. 260 g (con batterie)



**Dati tecnici MD 110**

Batteria	4 microbatterie (AAA/LR 03)
Tempo di funzionamento	17h di funzionamento oppure 5000 misurazioni in modalità continua e con le funzioni di retroilluminazione e trasferimento dati Bluetooth® disattivi.
Memoria	Memoria circolare interna per 125 serie di dati
Interfaccia	Bluetooth® 4.0 per la trasmissione dei dati di misurazione memorizzati
Bluetooth® Modul:	Spezifikationen: Modul: BLE113-A Bluetooth® 4.0 LE FCC ID: QOQBT113 IC: 5123A-BGTBLE113
Dimensioni	155 x 75 x 35 mm (l x l x a)
Peso	Apparecchio base ca. 260 g (con batterie)

**Dati tecnici MD 200**

Batteria	4 batterie (Mignon AA/LR 6)
Tempo di funzionamento	53h aziendale periodo rispettivamente 15000 misurazioni nella prova costante disattivare la retroilluminazione
Memoria	Memoria circolare interna per 16 serie di dati
Interfaccia	Interfaccia IR per la trasmissione dei dati di misurazione
Dimensioni	190 x 110 x 55 mm (l x l x a)
Peso	Apparecchio base ca. 455 g (con batterie)

### Indicazioni per l'utente

<b>Hi</b>	Intervallo di misurazione superato o troppo intorbidamento.
<b>Lo</b>	Intervallo di misurazione troppo ridotto.
	Sostituire immediatamente le batterie, impossibile procedere con l'operazione.
<b>btLo</b>	Tensione delle pile insufficiente per la retro-illuminazione dell display. Misura tuttavia possibile.
	Quando il metodo è stato regolato dall'utente, con il risultato sul display viene visualizzata una freccia nella posizione Cal (vedi "Ripristino della regolazione del produttore").

### Messaggi di errore

<b>E27 / E28 / E29</b>	Assorbimento luce troppo elevato. Causa es.: gruppo ottico imbrattato
<b>E 10 / E 11</b>	Fattore regolazione fuori della gamma ammissibile.
<b>E 20 / E 21</b>	Il rilevatore riceve troppa luce.
<b>E23 / E24 / E25</b>	Il rilevatore riceve troppa luce.
<b>E 22</b>	La pila era troppo debole durante la misura. Cambiare la pila.
<b>E 70</b>	Questi messaggi di errore si riferiscono a una regolazione errata o mancante da parte dello stabilimento o dell'utilizzatore. Si prega di contattare la nostra Assistenza Tecnica scrivendo a techsupport@tintometer.de.
<b>E 71</b>	
<b>E 72</b>	
<b>:</b>	

• <b>Información Importante</b> .....	95
• <b>Observaciones generales</b> .....	96
Observaciones sobre la técnica de trabajo .....	96
Observaciones sobre los métodos .....	96
Colocación de la junta: .....	97
Colocación de la tapa de cubierta .....	97
Posicionamiento del adaptador .....	97
Posicionamiento de las cubetas .....	97
Llenado correcto de la cubeta .....	97
Manipulación correcta de los reactivos .....	97
Recambio de batería .....	98
• <b>Descripción de funciones</b> .....	99
Puesta en funcionamiento .....	99
Scroll Memory (SM) .....	99
Realizar una calibración a cero .....	99
OTZ (One Time Zero) .....	100
Vencimiento de la determinación .....	100
Iluminación de fondo de la indicación .....	100
Función Countdown / Tiempo de reacción .....	101
Lectura de datos memorizados .....	101
• <b>Menú opciones</b> .....	102
Menú-Abrir .....	102
Selección de menú .....	102
Lectura de datos memorizados .....	102
Transmisión de datos almacenados - a la impresora o al PC - para MD 100 y MD 200 ..	103
Transmisión de datos almacenados - Bluetooth® - para MD 110 .....	104
Ajuste de fecha y hora (en el formato de 24 horas) .....	105
• <b>Ajuste por el usuario</b> .....	106
Visualización de la configuración de calibración actual .....	106
Ajuste por el usuario .....	106
Modo de ajuste para el fluoruro .....	108
Retorno al ajuste de fabricación .....	109
• <b>Inspección del instrumento</b> .....	110
Uso de un kit de estándares de referencia .....	110
Uso de un kit de verificación estándar .....	111
• <b>Datos técnicos</b> .....	113
• <b>Observaciones al el usuario</b> .....	115
• <b>Mensajes de error</b> .....	115

## Indicación importante para los consumidores en la UE

### Indicación acerca de la eliminación de pilas y acumuladores



Basado en la norma relativa a pilas/ baterías (directiva 2006/66/CE), cada consumidor, está obligado por ley, a la devolución de todas las pilas/ baterías y acumuladores usados y consumidos. Está prohibida la eliminación en la basura doméstica. Ya que en productos de nuestra gama, también se incluyen en el suministro pilas y acumuladores, le sugerimos lo siguiente: Las pilas y acumuladores usados no pertenecen a la basura doméstica, sino que pueden ser entregados en forma gratuita en cada uno de los puntos de recolección públicos de su comunidad en los cuales se vendan pilas y acumuladores del tipo respectivo. Además, para el consumidor final existe la posibilidad de devolver las pilas y baterías recargables a los distribuidores donde se hayan adquirido (obligación legal de devolución).

### Eliminación de equipos eléctricos



Con motivo de la Directiva Europea 2012/19/UE, ¡ningún instrumento eléctrico deberá eliminarse junto con los residuos domésticos diarios! Nosotros se encargará de dichos instrumentos eléctricos de una manera profesional y sin dañar el medio ambiente. Este servicio, el cual excluye los gastos de transporte, es gratis y se aplicará únicamente a aquellos instrumentos eléctricos adquiridos después del 13 de agosto de 2005. Se ruega envíe esta instrumento eléctrico inservibles de Tintometer a carga pagada a su distribuidor.

## Seguridad - Indicaciones generales

La responsabilidad y garantía del fabricante por daños y daños derivados se extingue en caso de uso no indicado, de no observancia de las instrucciones de uso, de uso por parte de personal sin cualificación suficiente y de modificaciones arbitrarias en el aparato. El fabricante no se hace responsable de los costes o daños que puedan sufrir el usuario o terceras personas derivadas del uso del presente aparato, especialmente en caso de uso inadecuado, indebido o en caso de alteraciones en las conexiones o en el aparato. El fabricante no se hace responsable de los posible errores de imprenta.

## Informaciones sobre la seguridad en el manual de instrucciones

El presente manual de instrucciones contiene información importante para el manejo seguro del instrumento. Lea completamente el manual de instrucciones y familiarícese con el instrumento antes de ponerlo en funcionamiento o trabajar con el mismo. Tenga el manual de instrucciones siempre a mano para poder consultarlo en caso necesario.



### Observación:

La descripción de los métodos y el manejo de los reactivos no forman parte de este manual. Los archivos se encuentran en el adjunto soporte de datos o puede ser descargado desde nuestro sitio web.

## Observaciones sobre la técnica de trabajo

1. Limpiar minuciosamente las cubetas, las tapas y la varilla de agitar **después de cada determinación**; de este modo se evitará la acumulación de errores. Aún mínimas cantidades de reactivos pueden conducir a resultados erróneos.
2. Antes de comenzar con la determinación deberán de estar las cubetas, así como las caras exteriores de éstas totalmente limpias y secas. Huellas dactilares o gotas de agua en la superficie óptica de las cubetas pueden producir resultados erróneos.
3. El ajuste de cero y el análisis deben ser realizados con la misma cubeta, ya que las cubetas muestran poca tolerancia entre sí.
4. Coloque la cubeta para la calibración a cero y para la determinación en el compartimento de medición de tal forma, que la graduación con el triangulo blanco se encuentre dirigida a la marca de la carcasa.
5. La calibración a cero y el test se han de realizar con la tapa de la cubeta cerrada. La tapa debe de poseer un anillo de obturación.
6. La aparición de burbujas en la cara interior de la cubeta puede producir resultados erróneos. En este caso, cerrar la tapa de la cubeta y agitar hasta la desaparición total de las burbujas antes de realizar la determinación.
7. Evitar la penetración de agua en el compartimento de medición que puede producir la destrucción de componentes electrónicos o daños por corrosión y así causar resultados incorrectos.
8. Las suciedades en el pozo de medida transparente conducen a mediciones falsas. Las superficies de entrada de luz del pozo de medida transparente se deberán revisar periódicamente y limpiarse si es necesario. Para la limpieza son aptos paños y bastoncillos de algodón sin pelusa humedecidos (sin aceite).
9. Grandes diferencias de temperatura entre el fotómetro y el medio ambiente pueden dar lugar a medidas incorrectas, por ejemplo, por la formación de condensación en el pozo de medida y en la cubeta.
10. Proteger el aparato durante el funcionamiento de los rayos solares directos.
11. Las tabletas reactivas se añadirán a la prueba acuosa directamente de su envoltura, sin tocarlas con los dedos.
12. Cumplir estrictamente el orden de incorporación de los reactivos.

## Observaciones sobre los métodos

- Observar las posibilidades de empleo, la prescripción de análisis y los efectos de matriz de los métodos.
- Diferentes packs de recambio disponible a petición.
- Los reactivos están destinados al análisis químico y no deben estar al alcance de los niños.
- Eliminar reglamentariamente las soluciones reactivas.
- Solicitar las fichas de datos de seguridad que se necesiten.  
(Internet: [www.lovibond.com](http://www.lovibond.com))



## ES Observaciones generales

### Colocación de la junta:



### Colocación de la tapa de cubierta:

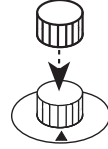

### Posicionamiento del adaptador

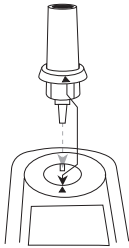

### Posicionamiento de las cubetas:

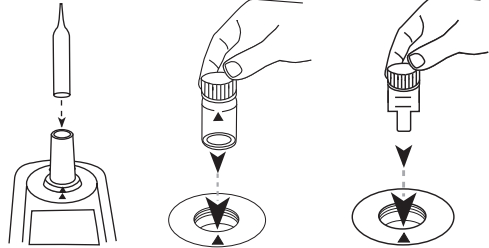

### Llenado correcto de la cubeta:

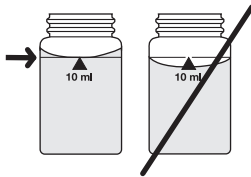

### Manipulación correcta de los reactivos:

#### Sobre de polvos

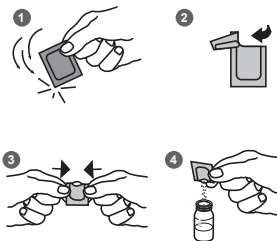

#### Reactivo líquido

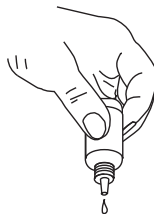

#### Tabletas en blíster

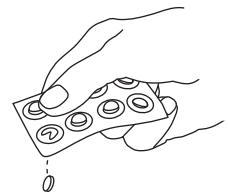

## ES Observaciones generales

### Recambio de batería:

MD 100 / MD 110

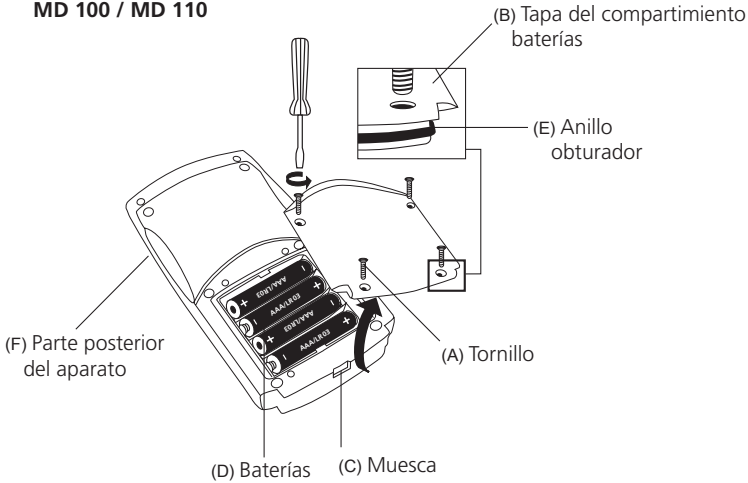

MD 200

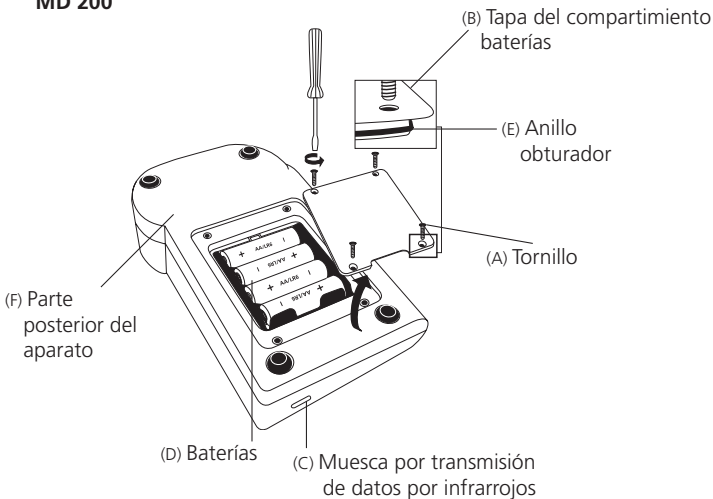

### ATENCIÓN:

**Para poder garantizar una hermeticidad completa del fotómetro, deberá estar puesto el anillo obturador (E) y estar atornillada la tapa del compartimento de baterías (B).**

Si se extrae la batería del dispositivo por más de 1 minuto, al volver a abastecerlo de corriente (insertar la batería nueva) aparecerá automáticamente el programa de fecha y hora al encender al dispositivo.

### Puesta en funcionamiento



Encender el aparato



Elección de un método



### Scroll Memory (SM)

Para los dispositivos de multiparámetro está establecido el orden de los diferentes métodos. Después de encender el dispositivo se mostrará automáticamente el último método que había sido elegido antes de haber sido apagado el aparato. Con ello se permitirá un acceso más rápido a los métodos favorecidos.



### Observaciones:

La descripción de los métodos y la manipulación de los reactivos no son parte de estas instrucciones, se incluyen en un documento separado.



### Método de fluoruros

#### Atención:

Antes del empleo inicial se deberán efectuar una adaptación del método (véase "Selección de menú": ▼ Modo de ajuste para el fluoruro). El ajuste del aparato y la determinación se deberán de realizar con el mismo batch del reactivo-SPADNS. El ajuste del aparato se deberá realizar para cada nuevo batch de reactivo-SPADNS.

### Realizar una calibración a cero



Llenar la cubeta de 24 mm con 10 ml de muestra.

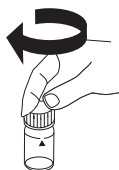

Cerrar la cubeta



Poner la cubeta de muestra en el compartimiento de medición.  
¡Debe tenerse en cuenta el posicionamiento!

## ES Descripción de funciones



Pulsar la tecla [ZERO/TEST]

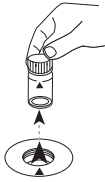

Extraer la cubeta del compartimiento de medición.

### OTZ (One Time Zero)

One Time Zero está disponible para todas las versiones de fotómetro para las que el ajuste cero se realiza en una cubeta redonda de 24 mm con muestra de agua. Se puede utilizar cuando se realizan distintas pruebas con idénticas condiciones y con la misma muestra de agua. Al cambiar de método no es necesario volver a realizar el ajuste cero, la prueba puede realizarse directamente. El ajuste cero se guarda hasta que se desconecta el instrumento.

Si es necesario se podrá realizar un nuevo ajuste a cero en cualquier momento.



Ejecutar el ajuste cero (OTZ) 1 vez, luego medición de los parámetros



Un nuevo ajuste a cero, Presionar la tecla durante 2 segundos.

## Vencimiento de la determinación



Añadir reactivo (por ejemplo una tableta) (ver descripción de los métodos)

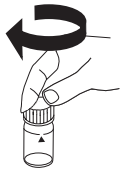

Cerrar la cubeta

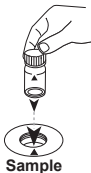

Poner la cubeta de muestra en el compartimiento de medición.  
¡Debe tenerse en cuenta el posicionamiento!



Pulsar la tecla [ZERO/TEST]

## Iluminación de fondo de la indicación



Presionar, durante el proceso de medición la iluminación de fondo se apaga automáticamente

### Función Countdown / Tiempo de reacción

En algunos métodos con tiempo de reacción es posible activar una función Count-Down durante la realización de la prueba.

presionar y **mantenerla apretada**

presionar

soltar

El Countdown/tiempo de reacción corre, la medición se realiza automáticamente al finalizar el tiempo.

Cancelar Countdown/tiempo de reacción

**Atención:**

**si Ud. no mantiene el tiempo de reacción los resultados de las misuras pueden ser incorrectos.**



### Observación:

La descripción de los métodos y la manipulación de los reactivos no son parte de estas instrucciones, se incluyen en un documento separado.



### Lectura de datos memorizados

El instrumento está equipado con una memoria cíclica interna. Pueden consultarse los últimos 16 valores de medición.

Conectar instrumento

Mantener la tecla apretada durante más de 4 segundos, a continuación dejar la tecla, para llegar directamente al menú de memoria

Desplazarse por los registros de datos

Repetición del registro de datos

Retorno al modo de medición

Visualización en el formato siguiente (línea por línea en secuencia automática, 3 segundos por línea, hasta la indicación del resultado):

Número correlativo	n xx (xx: 16...1)
Año	YYYY (p. ej. 2014)
Fecha	MM.dd (MesMes.DíaDía)
Hora	hh:mm (HoraHora:MinutoMinuto)
Método	Símbolo del método
Resultado	x,xx



### Menú-Abrir

El dispositivo está apagado

presionar y **mantenerla apretada**

presionar brevemente, soltar

soltar



### Selección de menú

presionar para seleccionar el punto del menú ("desplazarse")

La selección de los siguientes puntos del menú:

diS Lectura de datos memorizados

Prt Transmisión de datos almacenados

Ajuste de fecha y hora

Ajuste por el usuario

El punto del menú seleccionado es indicado por una flecha en la pantalla.



oder



en función de la versión del instrumento

### diS – Lectura de datos memorizados

Abrir menú (ver "Menú-Abrir")

Desplazarse por los registros de datos

Repetición del registro de datos

Retorno al modo de medición

El instrumento está equipado con una memoria cíclica interna. Pueden consultarse los últimos 16 valores de medición.

Visualización en el formato siguiente (línea por línea en secuencia automática, 3 segundos por línea, hasta la indicación del resultado):

Número correlativo	n xx (xx: 16...1)
Año	YYYY (p. ej. 2014)
Fecha	MM.dd (MesMes.DíaDía)
Hora	hh:mm (HoraHora:MinutoMinuto)
Método	Símbolo del método
Resultado	x,xx





## ▲ Prt – Transmisión de datos almacenados - a la impresora o al PC - para MD 100 y MD 200

**Atención:** Para transferir los datos almacenados a una impresora o un PC será necesario un módulo de transferencia de datos con infrarrojos (IRiM) a la venta en forma opcional. Se puede usar en combinación con los instrumentos MD 100 y MD 200.

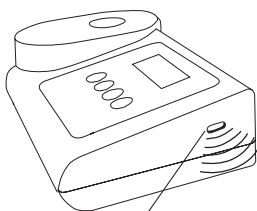
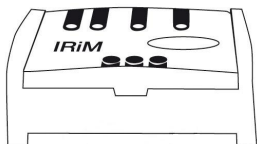

Muesca por transmisión de datos por infrarrojos

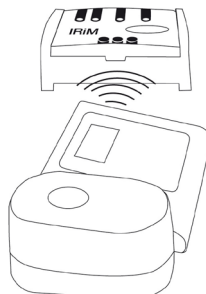

**PrtG**



Abrir menú (ver "Menú-Abrir")

presionar

El módulo IRiM y los aparatos periféricos deberán estar preparados para el funcionamiento. El dispositivo mostrará "PrtG" (Printing) durante aprox. 1 segundo

presionar

Luego se mostrará el número del primer juego de datos y serán transferidos los datos. Todos los juegos de datos almacenados serán transferidos uno tras otro. Después de terminada la transferencia el dispositivo cambia a modo de medición.



**E 162**

El proceso de impresión puede ser cancelado pulsando la tecla [On/Off]. El dispositivo se apaga.

Si no fuera posible la comunicación con un IRiM, después de aprox. 2 minutos se interrumpirá la comunicación. Se mostrará el número de error **E 162** durante aprox. 4 segundos, luego el dispositivo volverá al modo de medición normal (véanse también las instrucciones IRiM).

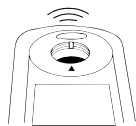

## **▲ Prt – Transmisión de datos almacenados - Bluetooth® - para MD 110**

El MD 110 dispone de una interfaz Bluetooth® 4.0 que permite una transmisión inalámbrica de los resultados de medición. Así es posible transmitir como los resultados almacenados en la memoria. Bluetooth® 4.0 también es conocido como Bluetooth® Smart o Bluetooth® LE (low energy). Los datos son transferidos por el fotómetro en formato csv. Para obtener una definición de la información transferida por el fotómetro, consulte [www.lovibond.com](http://www.lovibond.com). Para recibir los datos, Tintometer GmbH ofrece varias soluciones distintas.

La App AquaLX® permite operar con terminales móviles, ya que gestiona y evalúa gráficamente los datos recibidos. Tanto los datos como los gráficos pueden reenviarse directamente vía correo electrónico. AquaLX® puede descargarse gratuitamente para iOS® en iTunes Store® y para Android™ en Google Play™ Store gratuitamente.

Una herramienta de software permite recibir en el PC los datos almacenados en el fotómetro. Los datos pueden exportarse en formato Excel®, que a su vez puede utilizarse como herramienta de evaluación del modo habitual para el usuario. Si no se dispusiera de Excel®, los datos pueden guardarse alternativamente en formato de archivo de texto \*.txt y quedan así disponibles para una evaluación posterior. Para recibir los datos del equipo es necesario el uso del adaptador Bluetooth® suministrado con el software.

Artículo	Nº de pedido
Software, incluido el dongle de Bluetooth®	2444480



Abrir menú (ver "Menú-Abrir")

presionar

presionar

Los aparatos periféricos deberán estar preparados para el funcionamiento.

La pantalla muestra el estado de la conexión Bluetooth®.

En la pantalla aparece: „ncon“ (not connecting).

Puede ser necesaria una actualización de la lista de dispositivos periféricos reconocidos por el software. Vea a seguir las instrucciones del AquaLX u del software de transmisión de datos para el adaptador Bluetooth®.

En la pantalla aparece: „con“ (connecting).

Presionando la tecla [MODE] se inicia la transferencia, el dispositivo mostrará „PrtG“ (Printing) durante la transferencia de datos y el establecimiento de una conexión.





Todos los juegos de datos almacenados serán transferidos uno tras otro. Después de terminada la transferencia el dispositivo cambia a modo de medición y se pierde la conexión de Bluetooth®.

La transmisión puede ser cancelada a cualquier momento pulsando la tecla [On / Off]. El dispositivo se apaga.



### Ajuste de fecha y hora (en el formato de 24 horas)

Abrir menú (ver "Menú-Abrir")



Pulsar 2 veces = símbolo de la flecha en Time & Date



confirmar



Aumentar valor



Reducir valor



Confirmar la configuración correspondiente



Después de la última confirmación, "IS SET" aparece en la pantalla.

El aparato regresa automáticamente al modo de medición.

## Visualización de la configuración de calibración actual

### Abrir menú (ver "Menú-Abrir")



3x = símbolo de flecha en Cal o Cal en la pantalla

confirmar

CAL

MÉTODO

En la pantalla aparece alternativamente: CAL/"Método".

cAL

Ajuste por el usuario

CAL

Ajuste de fabricación



## 4 Ajuste por el usuario

Abrir menú (ver "Menú-Abrir")



3x = símbolo de flecha en Cal o Cal en la pantalla

confirmar

CAL

MÉTODO

En la pantalla aparece alternativamente: CAL/"Método".



Elección de un método



Llenar la cubeta de 24 mm con 10 ml de muestra.

La muestra debe estar compuesta de agua incolora y clara (por ejemplo, agua desionizada, agua potable pura).

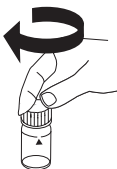

Cerrar la cubeta.

## ES Ajuste por el usuario



Poner la cubeta en el compartimiento de medición.  
¡Debe tenerse en cuenta el posicionamiento!

presionar

⇒ MÉTODO ⇐

parpadea durante unos 8 segundos

0.0.0

CAL

La confirmación del ajuste a cero 0.0.0 aparece en alternancia con CAL.

Zero  
Test

Realizar la medición con un patrón de concentración conocida.

presionar

⇒ MÉTODO ⇐

parpadea durante unos 3 segundos

RESULTADO

El resultado aparece en alternancia con CAL.

CAL

Si el resultado coincide con el valor del patrón utilizado (dentro de la tolerancia a tener en cuenta), se sale del modo.

On  
Off

presionar

Si el resultado está fuera del valor (teniendo en cuenta la tolerancia), modificar el valor visualizado:

Mode

Presionar 1 vez aumenta el resultado indicado en 1 dígito

Zero  
Test

Presionar 1 vez disminuye el resultado indicado en 1 dígito.

Presionar repetidamente las teclas hasta que el resultado indicado coincida con el valor del patrón utilizado.

CAL

El resultado aparece en alternancia con CAL.

RESULTADO + x

Mantener la tecla apretada durante más de 4 segundos

On  
Off

El ajuste de la aplicación ha terminado y está guardado.

#### **4** Modo de ajuste para el fluoruro

##### **El ajuste ocurre también:**

0 mg/l y 1 mg/l el estándar F y una cubeta limpia (ver descripción de los métodos, Obs.)

##### **Calibración de fluoruro:**

Abrir menú (ver "Menú-Abrir")



3x = símbolo de flecha en Cal o Cal en la pantalla



confirmar

**CAL**

Después de confirmar la selección mediante la tecla [MODE] aparece alternadamente en la pantalla: CAL/F.

**F**

Llenar una cubeta limpia 24 mm con 10 ml de agua desionizada, cerrándola a continuación con su tapa.



Colocar la cubeta en el compartimento de medición, según posición

**F**

Presionar la tecla [ZERO/TEST].

El símbolo del método parpadea durante unos 8 segundos.

**0.0.0**

La confirmación del ajuste a cero 0.0.0 aparece en alternancia con CAL.

**CAL**

Añadir a los 10 ml de agua desionizada **2 ml exactos de solución reactiva SPADNS**. Cerrar fuertemente la cubeta con su tapa y agitar a continuación.

Colocar la cubeta en el compartimento de medición, según posición



Presionar la tecla [ZERO/TEST].

**F**

El símbolo del método parpadea durante unos 3 segundos.

**F0**

En la pantalla aparece:

Sacar la cubeta del compartimento de medición y limpiar minuciosamente la cubeta y la tapa añadiendo a continuación **10 ml exactos de estándar de fluoruro** (concentración 1 mg/l F).

Añadir a los 10 ml de estándar de fluoruro 2 ml exactos de solución reactiva SPADNS. Cerrar fuertemente la cubeta con su tapa y agitar a continuación.

Colocar la cubeta en el compartimento de medición, según posición



Presionar la tecla [ZERO/TEST].

**F**

El símbolo del método parpadea durante unos 3 segundos.

En la pantalla aparece:

## ES Ajuste por el usuario

F1



: :

Apretando la tecla [ON/OFF] se calcula el nuevo factor de corrección y se guarda en el nivel de ajuste del usuario.

En la pantalla aparece durante 3 segundos la confirmación del ajuste.



### Retorno al ajuste de fabricación

El retorno desde el ajuste del usuario al ajuste de fabricación sólo es posible conjuntamente para todos los métodos.

En el caso de un método que haya sido ajustado por el usuario, el resultado en la pantalla es indicado un símbolo "Cal".

Para retornar el aparato al ajuste de fabricación se procede como sigue:

presionar y **mantenerla apretada**

presionar brevemente, soltar

Después de aprox. 1 segundo soltar las teclas.

En la pantalla aparece alternadamente:

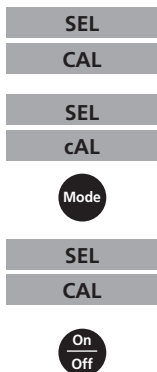

Ajuste de fabricación

o:

Ajuste por el usuario

Apretando la tecla se activa simultáneamente el ajuste de fabricación para todos los métodos.

En la pantalla aparece alternadamente:

El aparato se apaga con la tecla [ON/OFF].

## ES Inspección del instrumento



### Uso de un kit de estándares de referencia (ver también página 107 Kits de estándares de referencia para MD 100, MD 110 y MD 200)

Elegir de conformidad con las instrucciones de servicio el método adecuado, considerando el sistema de reactivo utilizado (tableta, reactivo líquido o en polvo (powder pack)).

El reactivo líquido será medido en procedimiento de tableta.



Enciende el dispositivo.



Elección de un método.



Poner la cubeta Estándares de referencia „Zero“ en el compartimiento de medición. ¡Debe tenerse en cuenta el posicionamiento!

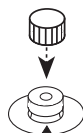

cerrar la tapa de cubierta



Presionar la tecla [ZERO/TEST].

0.0.0

Confirmación del ajuste cero



Extraer la cubeta del compartimiento de medición.



Colocar el estándar de referencia para el método correspondiente en el compartimiento de medición. ¡Debe tenerse en cuenta el posicionamiento!.



Presionar la tecla [ZERO/TEST].

RESULTADO

El resultado será comparado con el valor documentado en el certificado de prueba y teniendo en consideración las tolerancias (estándar y dispositivo). ¡Prestar atención en la asignación correcta con los sistemas de reactivos seleccionados!

## ES Inspección del instrumento



En caso de que el resultado esté fuera de la tolerancia, debe comprobarse la durabilidad del estándar y si el fotómetro está en calibración de fábrica. Si fuera así, se recomienda devolver el instrumento al fabricante o distribuidor.

### Estándares de referencia para MD 100, MD 110 y MD 200

Los estándares de referencia se utilizan exclusivamente para comprobar la precisión de medición para el fotómetro que aparece listado en el certificado de pruebas. En condiciones de trabajo normales, la calibración de estos instrumentos es estable a largo plazo. El fotómetro no puede calibrarse con los estándares de referencia.

Los estándares de referencia se suministran en cubetas bien cerradas.

Los valores nominales para cada estándar están documentados en el certificado. La durabilidad de los estándares de referencia asciende a dos años desde la fecha de fabricación con un uso y un almacenamiento adecuados. Limpiar siempre el exterior de las cubetas con un paño limpio antes de utilizarlas.

No. de pedido	Artículo	Campo de como
275650	<b>Kit de cloro</b> para instrumentos con reactivo en tabletas/reactivos líquidos	0,2* + 1,0* mg/l
275655	<b>Kit de cloro</b> para instrumentos con reactivo en tabletas/reactivos líquidos	0,5* + 2,0* mg/l
275656	<b>Kit de cloro</b> para instrumentos con reactivo en tabletas/reactivos líquidos	1,0* + 4,0* mg/l
275660	<b>Kit de cloro</b> para instrumentos con tabletas/reactivos en polvo	0,2* + 1,0* mg/l
275670	<b>Kit de pH</b> para instrumentos con tabletas/reactivos líquidos	7,45* pH

\* Valor indicativo, valor preciso según el certificado de análisis.

### Uso de un kit de verificación estándar (ver también kit de verificación estándar, página 110)



presionar y **mantenerla apretada**



presionar brevemente, soltar



soltar

## ES Inspección del instrumento

AbS

A530

En la pantalla aparece brevemente:

AbS seguida de las longitudes de onda por medir (por ejemplo, A530 para 530 nm).



En instrumentos con varios LED, seleccionar la longitud de onda deseada pulsando varias veces la tecla [Mode] (desplazarse).

Posicionar la cubeta marcada con "Zero" en el compartimiento de medición. Colocar la tapa de cubierta y pulsar la tecla [Zero/Test].

longitudes de onda

0.0.0

parpadea durante unos 3 segundos

Confirmación del ajuste cero



Agitar varias veces la cubeta marcada con la longitud de onda seleccionada y posicionarla en el compartimiento de medición.

longitudes de onda

parpadea durante unos 3 segundos

### RESULTADO



Comparar el resultado visualizado con el valor documentado en el certificado de prueba, teniendo en cuenta las tolerancias (ver también las indicaciones en el certificado).

En caso de que el resultado esté fuera de la tolerancia y los estándares estén dentro de la durabilidad, se recomienda devolver el instrumento al fabricante o distribuidor. Tiene sentido que el fabricante realice una comprobación, ya que además de la calibración también se comprueba si existen defectos técnicos en el instrumento.

### Estándares de verificación

Los estándares de verificación para el MD 100//MD 110//MD 200 sirven para la verificación de la precisión de la detección y la reproducibilidad de los resultados de medición respecto a las longitudes de ondas integradas.

El kit contiene una cubeta en blanco y 6 cubetas de medición distintas para la verificación de 6 longitudes de onda distintas. De este modo, el kit de verificación estándar permite comprobar todas las líneas MD 100//MD 110//MD 200 del fotómetro.

La durabilidad de los estándares asciende a dos años desde la fecha de fabricación con un uso y un almacenamiento adecuados. Las mediciones se efectúan en unidades de mAbs.

No. de pedido	Artículo
21 56 70	Estándares de verificación MD 100 / MD 110 / MD 200



**Datos técnicos MD 100, MD 110, MD 200**

Dispositivo	selección automática de longitud de onda, colorímetro con lectura directa
Elementos ópticos	LEDs, filtro de interferencia (IF) y fotosensor en el pozo de medida transparente Especificaciones de longitud de onda de los filtros de interferencia en función de la versión del instrumento, máximo 3 longitudes de onda posibles longitudes de onda montadas: 430 nm $\Delta\lambda = 5$ nm 530 nm $\Delta\lambda = 5$ nm 560 nm $\Delta\lambda = 5$ nm 580 nm $\Delta\lambda = 5$ nm 610 nm $\Delta\lambda = 6$ nm 660 nm $\Delta\lambda = 5$ nm
Campo fotométrico	-2600 - 2600 mAbs
Precisión de longitud de ondas	$\pm 1$ nm
Exactitud fotométrica*	3 % FS (T = 20 °C – 25 °C)
Resolución fotométrica	0,01 A
Auto-OFF	Desconexión automática del aparato 10 o 25 minutos tras la última pulsación de la tecla (tiempos de reacción distintos dependiendo del método disponible)
Visualización	LCD con iluminación de fondo (al presionar una tecla)
Hora	Reloj en tiempo real y fecha
Ajuste	Ajuste de fabricación y ajuste por el usuario. El retorno desde al ajuste de fabricación es posible en todo momento.
Condiciones ambientales	temperatura: 5–40°C 30–90% de humedad relativa (no condensante)
Resistente al agua	IP 68 análogo (1 hora para 0,1 m); flotable aparatos
CE	Certificado de declaración de conformidad de la comunidad europea véase <a href="http://www.lovibond.com">www.lovibond.com</a>

\*analizada con soluciones estándares



La precisión especificada del sistema se garantiza sólo para su uso con nuestros reactivos originales.

### Datos técnicos MD 100

Abastacimientode corriente	4 pilas micro (AAA/LR 03)
Tiempo de funcionamiento	17h tiempo de funcionamiento respectivamente 5000 mediciones en prueba de larga duración apagado la iluminación de fondo
Capacidad de memoria	memoria interna para 16 juegos de datos
Interface	Interface IR para transmisión de datos de medición
Dimensiones	155 x 75 x 35 mm (l x a x a)
Peso	instrumento base 260 g aprox. (con pilas)

### Datos técnicos MD 110

Abastacimientode corriente	4 pilas micro (AAA/LR 03)
Tiempo de funcionamiento	17h tiempo de funcionamiento o 5000 pruebas en modo continuo con la iluminación de fondo apagada y sin el uso de la transferencia de datos Bluetooth®.
Capacidad de memoria	memoria interna para 125 juegos de datos
Interface	Bluetooth® 4.0 para la transmisión de los datos de medición almacenados
Bluetooth® Modul:	Spezifikationen: Modul: BLE113-A Bluetooth® 4.0 LE FCC ID: QOQBT113 IC: 5123A-BGTBLE113
Dimensiones	155 x 75 x 35 mm (l x a x a)
Peso	instrumento base 260 g aprox. (con pilas)

### Datos técnicos MD 200

Abastacimientode corriente	4 pilas (Mignon AA/LR 6)
Tiempo de funcionamiento	53h tiempo de funcionamiento respectivamente 15000 mediciones en prueba de larga duración apagado la iluminación de fondo
Capacidad de memoria	memoria interna para 16 juegos de datos
Interface	Interface IR para transmisión de datos de medición
Dimensiones	190 x 110 x 55 mm (l x a x a)
Peso	instrumento base 455 g aprox. (con pilas)

## Observaciones al el usuario

**Hi**

Se ha superado el intervalo de medida o la turbidez es demasiado grande.

**Lo**

No se ha alcanzado el intervalo de medida.



Sustituir inmediatamente las baterías, no es posible continuar el trabajo.

**btLo**

Insuficiente tensión de las pilas para el retroalumbrado del LCD. Medida no obstante posible.

Store  
Cal **RESULTADO** Date  
Time Cal

En el caso de un método que haya sido ajustado por el usuario, al mostrarse el resultado en la pantalla es indicada una flecha en la posición Cal (véase “Retorno al ajuste de fabricación”).

## Mensajes de error

**E27 / E28 / E29**

Absorción de la luz demasiado grande.  
Causa p. ej.: Elementos ópticos ensuciados.

**E 10 / E 11**

Factor de ajuste fuera de la gama permitida.

**E 20 / E 21**

El detector recibe demasiada luz.

**E23 / E24 / E25**

El detector recibe demasiada luz.

**E 22**

La pila era demasiado escasa durante la medida. Cambiar la pila.

**E 70**

Estos mensajes de error se refieren a una calibración de fabricación o aplicación que falta o es defectuosa. Por favor, contacte con nuestro soporte técnico en [techsupport@tintometer.de](mailto:techsupport@tintometer.de).

**E 71**

**E 72**

**:**

- **Informação Importante** . . . . . 117
  
- **Indicações gerais** . . . . . 118
  - Indicações sobre a técnica de trabalho . . . . . 118
  - Indicações sobre os métodos . . . . . 118
  - Colocação do anel de vedação . . . . . 119
  - Colocação da tampa de cobertura . . . . . 119
  - Posicionamento do adaptador . . . . . 119
  - Posicionamento da célula . . . . . 119
  - Enchimento correcto do tubo . . . . . 119
  - Manuseamento correto dos reagentes . . . . . 119
  - Substituição das pilhas . . . . . 120
  
- **Descrição do funcionamento** . . . . . 121
  - Colocação em funcionamento . . . . . 121
  - Scroll Memory (SM) . . . . . 121
  - Executar um balanço zero . . . . . 121
  - OTZ (One Time Zero) . . . . . 122
  - Sequência de uma medição . . . . . 122
  - Iluminação de fundo do visor . . . . .
  - Contagem decrescente / Tempo de reacção . . . . . 123
  - Leitura de dados guardados . . . . . 123
  
- **Opções do menu** . . . . . 124
  - Aceder ao menu . . . . . 124
  - Seleccção do menu . . . . . 124
  - Leitura de dados guardados . . . . . 124
  - Transmissão de dados guardados - para a impressora ou PC - com MD 100 e MD 200 . . . . . 125
  - Transmissão de dados guardados - Bluetooth® - com MD 110 . . . . . 126
  - Acerto da data e da hora (formato de 24 horas) . . . . . 127
  
- **Calibração do utilizador** . . . . . 128
  - Apresentação da calibração atual . . . . . 128
  - Calibração do utilizador . . . . . 128
  - Modo de ajuste de fluoreto . . . . . 130
  - Reposição da calibração de fábrica . . . . . 131
  
- **Verificação do aparelho** . . . . . 132
  - Utilização de um kit padrão de referência . . . . . 132
  - Utilização de um kit padrão de verificação . . . . . 133
  
- **Dados técnicos** . . . . . 135
  
- **Indicações ao utilizador** . . . . . 137
  
- **Mensagens de erro** . . . . . 137

## Instruções importantes para os consumidores na UE

### Instruções para a eliminação residual de pilhas e acumuladores



Os utilizadores finais são legalmente responsáveis, nos termos do Regulamento relativo a pilhas e acumuladores (Directiva 2006/66/CE), pela entrega de todas as pilhas e acumuladores usados e gastos. É proibida a sua eliminação juntamente com o lixo doméstico. Uma vez que determinados produtos da nossa gama contêm pilhas e/ou acumuladores, alertamos para os seguintes aspectos: As pilhas e acumuladores usados não podem ser eliminados com o lixo doméstico, devendo sim ser entregues, sem encargos, junto dos pontos de recolha públicos do seu município, ou em qualquer ponto de venda de pilhas e acumuladores. O utilizador final dispõe ainda da possibilidade de entregar as pilhas e/ou acumuladores no estabelecimento comerciante onde os adquiriu (dever legal de aceitar a devolução).

### Remoção de Equipamento



Devido à Directiva Europeia 2012/19/UE, o seu equipamento eléctrico não deve ser removido com o lixo doméstico habitual! Nós tratará da remoção do seu equipamento eléctrico de forma profissional e responsável em termos ambientais. Este serviço, não incluindo os custos de transporte, é gratuito. Este serviço só é aplicável no caso de equipamentos eléctricos comprados depois de 13 de Agosto de 2005. Por favor, envie os seu aparelho eléctrico Tintometer que devem ser removidos ao seu fornecedor (transporte pago).

### Segurança - Indicações gerais

A responsabilidade e garantia do fabricante por danos e danos consequentes expira no caso de uso indevido, inobservância deste manual de utilização, aplicação de pessoal técnico sem qualificação suficiente, bem como modificação não autorizada do equipamento. O fabricante não se responsabiliza por custos ou danos incorridos pelo utilizador ou terceiros na sequência da utilização deste equipamento, especialmente no caso de uso indevido ou incorreto do equipamento ou falhas na ligação ou no equipamento. O fabricante não assume qualquer responsabilidade no caso de erros de impressão.

### Informações de segurança no manual de instruções

Este manual de instruções contém informações importantes para o funcionamento seguro do produto. Leia o manual de instruções na sua totalidade e familiarize-se com o produto antes de o colocar em funcionamento ou trabalhar com ele. Mantenha o manual de instruções sempre em local acessível para posterior consulta.



#### Indicação:

A descrição dos métodos e o manuseio dos reagentes não fazem parte deste manual. Eles estão localizados no suporte de dados incluso ou podem ser baixados do nosso site.

## Indicações sobre a técnica de trabalho

1. Os tubos, tampas e varetas devem ser cuidadosamente lavados **após cada análise**, para evitar erros de transferência. Mesmo pequenos vestígios de reagentes podem originar erros nas medições.
2. Antes de realizar a análise, o exterior dos tubos deve estar limpo e seco. Impressões digitais ou gotas de água na superfície transparente dos tubos podem originar erros de medição.
3. A reposição a zero e o teste devem ser efectuados com o mesmo tubo, pois os tubos podem apresentar pequenas diferenças entre si.
4. Quer para a reposição a zero, quer para o teste, o tubo deve ser sempre colocado na câmara de medição de forma que a graduação com o triângulo branco fique virada para a marca da caixa.
5. A reposição a zero e o teste devem ser efectuados com a tampa do tubo fechada. A tampa do tubo deve ter uma anilha de vedação.
6. A formação de pequenas bolhas no interior do tubo pode originar erros de medição. Caso se verifique a presença de bolhas, antes de efectuar o teste feche o tubo com a tampa e agite-o, para as eliminar.
7. Não deve entrar água na câmara de medição, este podem originar resultados de medição incorrectos.
8. Se a câmara de medição transparente estiver suja pode originar erros de medição. As superfícies translúcidas da câmara de medição transparente devem ser inspeccionadas regularmente e, se necessário, devem ser limpas. A sua limpeza pode ser feita com um pano humedecido que não largue fios (sem lubrificante) ou com cotonetes.
9. Grandes diferenças de temperatura entre o fotómetro e o ambiente envolvente podem originar erros de medição, por ex., devido à formação de condensação na câmara de medição ou no tubo.
10. Evite a utilização do aparelho sob a luz directa do sol.
11. As pastilhas reagentes devem ser colocadas directamente do invólucro na amostra de água, sem tocarem nos dedos.
12. A ordem de junção dos reagentes deve ser estritamente cumprida.

## Indicações sobre os métodos

- Respeitar o campo de aplicação, a regulamentação para a realização de análises e os efeitos de matriz dos métodos.
- Pacotes de recarga diferentes disponíveis a pedido.
- Os reagentes destinam-se especificamente à análise química e devem ser mantidos fora do alcance das crianças.
- Eliminar as soluções de reagentes da forma regulamentar.
- Em caso de necessidade, solicitar Fichas Técnicas de Segurança.  
(Internet: [www.lovibond.com](http://www.lovibond.com))

## PT Indicações gerais

Colocação do anel de vedação:

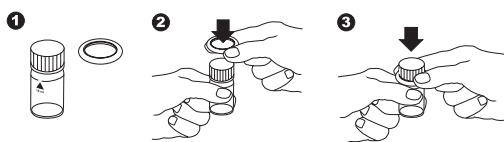

Colocação da tampa de cobertura:



Posicionamento do adaptador:

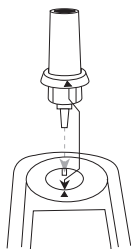

Posicionamento da célula:

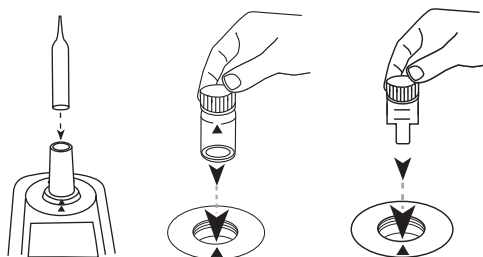

Enchimento correcto do tubo:

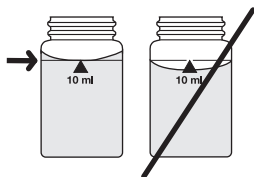

Manuseamento correto dos reagentes:

Saqueta de pó

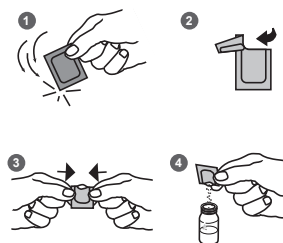

Reagente líquido

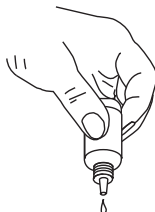

Pastilha de bolha

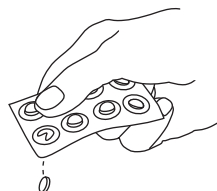

### Substituição das pilhas:

#### MD 100 / MD 110

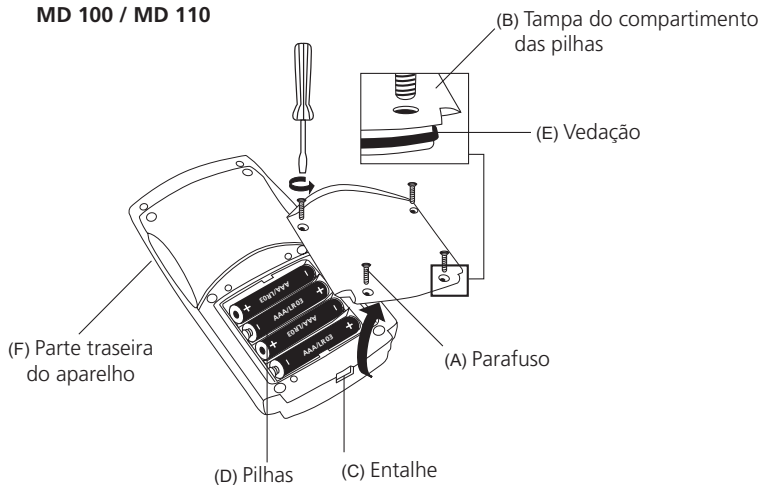

#### MD 200

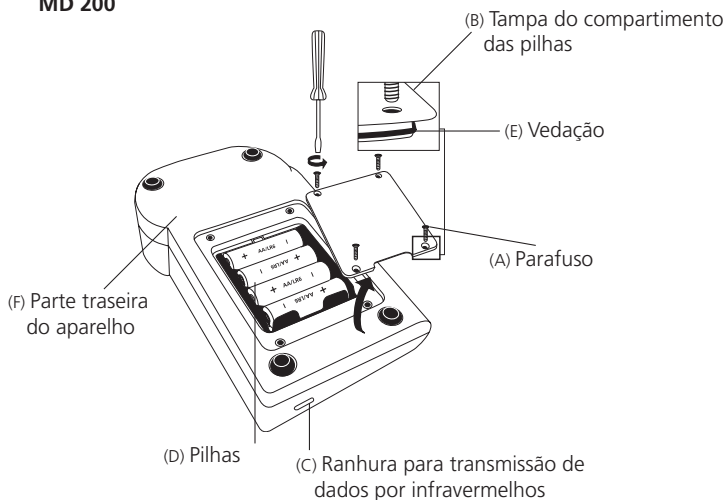

### Atenção!

**De modo a poder garantir uma estanqueidade completa do fotómetro, a anilha de vedação (E) tem de estar inserida e a tampa do compartimento das pilhas (B) tem de estar aparafusada.**

Se as pilhas estiverem mais de 1 minuto fora do aparelho, ao voltarem a receber corrente (quando introduzir pilhas novas) surge automaticamente o programa para acertar data e hora, ao voltar a ligar o aparelho.



## Colocação em funcionamento



Ligar o aparelho



Selecionar um método



### Scroll Memory (SM)

Em aparelhos de múltiplos parâmetros, a sequência dos diferentes métodos é pré-determinada. Após a activação do aparelho, é exibido automaticamente o método que tinha sido seleccionado por último antes da desactivação. Assim, é possibilitado um acesso mais rápido aos métodos favoritos.



### Indicação:

A descrição dos métodos e o manuseamento dos reagentes não fazem parte deste manual, mas estão incluídos num documento à parte.



### Método de fluoreto

#### Atenção:

Antes de colocar o instrumento em funcionamento pela primeira vez, é necessário ajustar os métodos (consultar "Seleção de menus":  Modo de ajuste de fluoreto). Para proceder ao ajuste e à medição da amostra, é necessário utilizar o mesmo lote de solução reagente SPADNS. O ajuste do aparelho deve ser realizado para cada lote novo de solução reagente SPADNS.

## Executar um balanço zero



Encher a célula de 24 mm com 10 ml de amostra

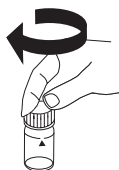

Fechar a célula



Colocar a célula de amostra no compartimento de medição. Observar o posicionamento.

## PT Descrição do funcionamento



Premir a tecla [ZERO/TEST]



Retirar a célula do compartimento de medição

### OTZ (One Time Zero)

O One Time Zero está disponível para todas as variantes do fotómetro, nas quais o balanço zero é efetuado numa célula circular de 24 mm com água de amostra. Pode ser utilizado quando se realizam diferentes testes sob condições de teste idênticas com a mesma amostra de água. Quando o método é mudado, deixa de ser necessário executar um novo balanço zero, podendo-se iniciar diretamente o teste. O balanço zero é memorizado até desligar o aparelho.

Se necessário, uma nova reposição a zero pode ser efectuada a qualquer momento.



One Time Zero (OTZ), 1x executar um balanço zero, de seguida medem-se os parâmetros



Novo balanço zero, premir a tecla durante 2 segundos

### Sequência de uma medição

Adicionar reagente (por exemplo um reagente em pastilha) (consultar a descrição completa do método)

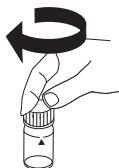

Fechar a célula



Colocar a célula de amostra no compartimento de medição.  
Observar o posicionamento.



Premir a tecla [ZERO/TEST]

### Iluminação de fundo do visor



Premir, durante o processo de medição, a iluminação do visor desliga-se automaticamente.

## Contagem decrescente / Tempo de reacção

No caso de métodos com tempo de reacção, pode ser ligada uma função de contagem decrescente (Count-Down) em alguns métodos, enquanto o teste é executado.



premir e **mantê-la premida**

premir

soltar

Contagem decrescente/tempo de reacção em curso, a medição ocorre automaticamente quando o tempo terminar.

Contagem decrescente / Tempo de reacção abortar



### Atenção!

**Se os tempos de reacção não forem respeitados podem originar resultados de medição incorrectos.**

### Indicação:

A descrição dos métodos e o manuseamento dos reagentes não fazem parte deste manual, mas estão incluídos num documento à parte.



## Leitura de dados guardados

O aparelho possui uma memória cíclica. Pode chamar os últimos 16 valores de medição.



Ligar o aparelho



premir durante mais de 4 segundos, depois soltar, para entrar directamente no menu de gravação



aceder aos conjuntos de dados



repetir conjunto de dados



regressar ao modo de medição

AApresentação no seguinte formato (linha a linha em sequência automática, 3 segundos por cada linha, até à indicação do resultado):

N.º de ordem	n xx (xx: 16...1)
Ano	YYYY (por ex., 2014)
Data	MM.dd (MêsMês.DiaDia)
Hora	hh:mm (HoraHora:MinutoMinuto)
Método	Indicação do método
Resultado	x,xx

### Aceder ao menu

Dispositivo está desligado

premir e **mantê-la premida**

premir brevemente, em seguida soltar

em seguida soltar



### Seleção do menu

premir para seleccionar ponto de menu ("scroll")

Seleccionar as seguintes opções do menu:

diS Ler dados guardados

Prt Transmissão de dados guardados

Acertar a data e a hora

Calibração do utilizador

A opção de menu seleccionada surge com uma seta no visor.



OU



dependendo da variante do aparelho

### diS – Leitura de dados guardados

Aceder ao menu (ver "Aceder ao menu")

aceder aos conjuntos de dados

repetir conjunto de dados

regressar ao modo de medição

O aparelho possui uma memória cíclica. Pode chamar os últimos 16 valores de medição.

Apresentação no seguinte formato (linha a linha em sequência automática, 3 segundos por cada linha, até à indicação do resultado):

N.º de ordem	n xx (xx: 16...1)
Ano	YYYY (por ex., 2014)
Data	MM.dd (MêsMês.DiaDia)
Hora	hh:mm (HoraHora:MinutoMinuto)
Método	Indicação do método
Resultado	x,xx





### ▲ Prt – Transmissão de dados guardados - para a impressora ou PC - com MD 100 e MD 200

**ATENÇÃO!** Para a transmissão dos dados guardados para uma impressora ou um PC, é necessário um módulo de transmissão de dados por infravermelhos (IRiM), disponível como opção. Esse pode ser usado juntamente com os aparelhos MD 100 e MD 200.

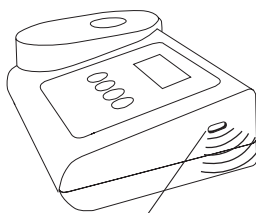
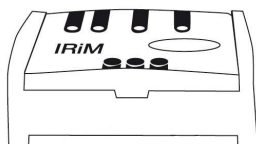

Ranhura para transmissão de dados por infravermelhos

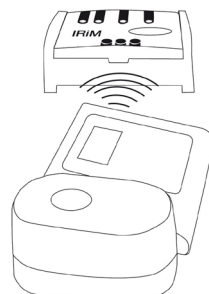

**PrtG**



**E 162**

Aceder ao menu (ver "Aceder ao menu")

premir

O IRiM e os aparelhos periféricos devem estar operacionais. Aparelho exibe a indicação "PrtG" (Impressão)

premir

Em seguida, o número do primeiro conjunto de dados é indicado e os dados são transmitidos. Todos os conjuntos de dados guardados são transmitidos sequencialmente. Após a conclusão, o aparelho comuta para o modo de medição.

O processo de impressão pode ser interrompido ao premir a tecla [On/Off]. O aparelho desliga-se.

Se não for possível estabelecer comunicação com um IRiM, surge uma interrupção após aprox. 2 minutos. Durante aprox. 4 segundos, é indicado o número de erro **E 162** e, em seguida, o aparelho volta para o modo de medição normal (consultar também o manual de instruções do IRiM).



## **▲ Prt – Transmissão de dados guardados - Bluetooth® - com MD 110**

O MD 110 apresenta uma interface Bluetooth® 4.0, que permite a transferência sem fios de resultados de medição. Aqui são transmitidos os resultados armazenados. Bluetooth® 4.0 é também conhecido como Bluetooth® Smart ou Bluetooth® LE (Low energy). Os dados são transferidos do fotómetro em formato .csv. Pode ser descarregada uma definição da informação transferida do fotómetro em [www.lovibond.com](http://www.lovibond.com). A Tintometer GmbH apresenta diversas soluções para a receção de dados.

Para dispositivos móveis, está disponível a aplicação AquaLX®, que gere os dados recebidos e avalia os gráficos. Tanto os dados como os gráficos podem ser diretamente encaminhados por e-mail. A AquaLX® pode ser descarregada gratuitamente para iOS® na iTunes Store® e para Android™ na loja Google Play™.

Uma ferramenta informática possibilita a receção dos dados gravados no fotómetro para um PC. Os dados podem ser exportados para uma folha de Excel®, que pode ser utilizada diretamente pelo utilizador como uma ferramenta de avaliação, da forma habitual. No caso do Excel® não se encontrar disponível, os dados podem, em alternativa, ser guardados em formato .txt ficando, assim, prontos para uma avaliação posterior. Para a receção dos dados do instrumento é necessário um adaptador Bluetooth® que é fornecido como software.

Artigo	Artigo n.º
Software, incluindo Dongle de Bluetooth®	2444480

Aceder ao menu (ver “Aceder ao menu”)



premir



premir

Os aparelhos periféricos devem estar operacionais.

O dispositivo apresenta o estado da ligação Bluetooth®.

No visor surge: „ncon” (not connecting).

Pode ser necessária uma atualização da lista de dispositivos periféricos reconhecidos pelo software. Para isso veja as instruções do AquaLX ou do software de transmissão de dados para o adaptador Bluetooth®.



No visor surge: „con” (connecting).



Ao apertar a tecla [MODE] é iniciada a transmissão, o aparelho exibirá a indicação "PrtG" (Printing) durante a transferência de dados e o estabelecimento de uma conexão.

Todos os conjuntos de dados guardados são transmitidos sequencialmente. Após a conclusão, o aparelho comuta para o modo de medição e conexão Bluetooth é interrompida.



A transmissão pode ser interrompida a qualquer momento pressionando a tecla [On/Off].



### **2 3** Acerto da data e da hora (formato de 24 horas)

Aceder ao menu (ver "Aceder ao menu")



2x premir = símbolos de seta em Time & Date



confirmar



aumentar valor



reduzir valor



confirmar a respetiva configuração



No visor aparece "IS SET" após a última confirmação.

Aparelho regressa automaticamente ao modo de medição.

### Apresentação da calibração atual

Aceder ao menu (ver "Aceder ao menu")



3x = símbolos de seta em Cal ou Cal no visor

confirmar

Alterna no visor entre: CAL/"Método".

#### Explicação:

Calibração do utilizador

Calibração de fábrica



### 4 Calibração do utilizador

Aceder ao menu (ver "Aceder ao menu")



3x = símbolos de seta em Cal ou Cal no visor

confirmar

Alterna no visor entre: CAL/"Método".



Selecionar um método



Encher a célula de 24 mm com 10 ml de amostra .

A amostra devia ser composta por água incolor e sem turvação (p. ex. água desmineralizada, água potável pura).

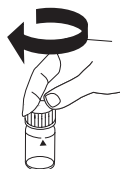

Fechar a célula



## PT Calibração do utilizador



Colocar a célula no compartimento de medição.  
Observar o posicionamento.

premir

MÉTODO

pisca durante aprox. 8 segundos

0.0.0

CAL

A confirmação da reposição a zero 0.0.0 surge em alternância com a palavra CAL.

Efectuar a medição com uma concentração padrão conhecida.

Zero  
Test

premir

MÉTODO

pisca durante aprox. 3 segundos

RESULTADO

CAL

O resultado surge alternando com a palavra CAL.

Quando o resultado coincide com o valor do padrão utilizado (dentro da tolerância que deve ser considerada), proceda ao modo de ajuste.

premir

On  
Off

Quando o resultado está fora do valor (tendo em conta a tolerância), altere o valor indicado:

1 x premir o resultado apresentado aumenta 1 dígito.

Mode

1 x premir o resultado apresentado diminui 1 dígito.

Zero  
Test

Premir a tecla repetidamente até o resultado indicado estar em conformidade com o valor padrão utilizado.

O resultado surge alternando com a palavra CAL.

CAL

RESULTADO + x

premir durante mais de 4 segundos

On  
Off

O ajuste da aplicação é concluído e memorizado.

#### 4 Modo de ajuste de fluoreto

##### O ajuste realiza-se com:

0 mg/l e 1 mg/l F padrão e uma cuvete limpa  
(consultar a descrição completa do método, obs.)

##### Ajuste do fluoreto:

Aceder ao menu (ver "Aceder ao menu")



3x = símbolos de seta em Cal ou Cal no visor



confirmar

CAL

Após confirmar a selecção premindo a tecla [MODE], surge alternadamente no visor: CAL/F.

F

Encher uma cuvete de 24 mm limpa com exactamente **10 ml de água desmineralizada** e fechar bem com a tampa da cuvete.



Colocar o tubo na câmara de medição. Posicionamento  $\Sigma$ .

F

Premir a tecla [ZERO/TEST].

A indicação do método pisca durante aprox. 8 segundos.

0.0.0

A confirmação da reposição a zero 0.0.0 surge em alternância com a palavra CAL.

CAL

Adicionar aos 10 ml de água desmineralizada **exactamente 2 ml de solução reagente SPADNS**. Fechar bem a cuvete com a tampa e misturar o conteúdo rodando a cuvete.



Colocar o tubo na câmara de medição. Posicionamento  $\Sigma$ .

F

Premir a tecla [ZERO/TEST].

A indicação do método pisca durante aprox. 3 segundos.

F0

No visor surge:

Retirar a cuvete do orifício de medição, limpar cuidadosamente a cuvete e a respetiva tampa e encher com **exactamente 10 ml de padrão de fluoreto (concentração 1 mg/l F)**.

Adicionar aos 10 ml de padrão de fluoreto **exactamente 2 ml de solução reagente SPADNS**. Fechar bem a cuvete com a tampa e misturar o conteúdo rodando a cuvete.



Colocar o tubo na câmara de medição. Posicionamento  $\Sigma$ .

F

Premir a tecla [ZERO/TEST].

A indicação do método pisca durante aprox. 3 segundos.

## PT Calibração do utilizador

F1



No visor surge:

O novo ajuste é memorizado premindo o botão [ON/OFF].

: :

No visor surge, durante 3 segundos, a confirmação da calibração.

### Reposição da calibração de fábrica

A reposição da calibração do utilizador para a calibração de fábrica tem sempre de ser feita em simultâneo para todos os métodos.

No caso de um método que tenha sido calibrado pelo utilizador, surge ao lado da indicação do resultado no visor uma seta na posição Cal.

Para repor no aparelho a calibração de fábrica, proceder do seguinte modo:



premir simultaneamente as teclas e mantê-las premidas



premir brevemente, em seguida soltar



Aprox. 1 segundo depois, soltar

SEL

No visor surge alternadamente:

CAL

Calibração de fábrica

**ou:**

SEL

Calibração do utilizador

cAL



Premindo a tecla [MODE] a calibração de fábrica é activada em simultâneo para todos os métodos.

SEL

No visor surge alternadamente:

CAL



O aparelho desliga-se premindo a tecla.

## PT Verificação do aparelho



### Utilização de um kit padrão de referência (ver também a página 129 dos kits padrão de referência para MD 100, MD 110 e MD 200)

De acordo com o manual de instruções, selecionar o respetivo método, considerando o sistema de reagentes usado (pastilha, reagente líquido ou Powder Pack). Com o uso de reagentes líquidos, o método de pastilha deve ser selecionado.



Ligar o aparelho



Selecionar um método.



Colocar a ampola "zero" de padrão de referência no compartimento de medição. Observar o posicionamento.

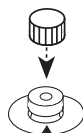

Colocar a tampa de cobertura



Premir a tecla [ZERO/TEST].

**0.0.0**

Confirmação do balanço zero

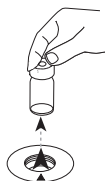

Retirar a célula do compartimento de medição.



Colocar o padrão de referência para o respetivo método no compartimento de medição. Observar o posicionamento.



Premir a tecla [ZERO/TEST].

**RESULTADO**

O resultado é comparado com o valor documentado no certificado de teste, tendo em conta as tolerâncias (padrão e aparelho). Observar



a correta correspondência relativamente aos sistemas de reagentes selecionados!

Se o resultado estiver fora da tolerância, deve verificar a sustentabilidade do padrão e ver se o fotómetro está na calibração de fábrica. Se isso ocorrer, recomenda-se a devolução do aparelho ao fabricante ou comerciante.

### **Kits de padrão de referência para MD 100, MD 110 e MD 200**

Os padrões de referência são unicamente usados para verificar a precisão de medição para os fotómetros que constam do certificado de teste. A calibração (ajuste) destes aparelhos é estável a longo prazo sob condições normais de trabalho. O fotómetro não pode ser calibrado com os padrões de referência.

Os padrões de referência são fornecidos em células firmemente fechadas.

Os valores nominais para cada padrão estão documentados no certificado. A sustentabilidade do padrão de referência ascende a dois anos a partir da data de fabrico quando o produto é usado e armazenado corretamente. Limpar as células sempre por fora com um pano limpo, antes de serem utilizadas.

<b>Número de ordem</b>	<b>Artigo</b>	<b>Faixa de medição</b>
275650	<b>Kit de cloro</b> para aparelhos com reagentes de pastilhas/reagentes líquidos	0,2* + 1,0* mg/l
275655	<b>Kit de cloro</b> para aparelhos com reagentes de pastilhas/reagentes líquidos	0,5* + 2,0* mg/l
275656	<b>Kit de cloro</b> para aparelhos com reagentes de pastilhas/reagentes líquidos	1,0* + 4,0* mg/l
275660	<b>Kit de cloro</b> para aparelhos com reagentes de pastilhas/reagentes em pó	0,2* + 1,0* mg/l
275670	<b>Kit pH para</b> aparelhos com reagentes de pastilhas/reagentes líquidos	7,45* pH

\* Valor de referência, valor exato conforme o certificado de análise.

### **Utilização de um kit padrão de verificação (ver também o kit de padrão de verificação, página 132)**



premir e **mantê-la premida**



premir brevemente, em seguida soltar



em seguida soltar

## PT Verificação do aparelho

AbS

A530

No visor aparece por breves momentos:

AbS seguido do comprimento de onda a medir (p. ex. A530 para 530 nm).

Mode

Zero  
Test

Em aparelhos com vários LEDs, selecione (scroll) o comprimento de onda pretendido premindo várias vezes a tecla [Mode].

comprimento  
de onda

Posicionar a célula identificada com “zero” no compartimento de medição. Colocar a tampa de cobertura e premir a tecla [Zero/Test].

0.0.0

pisca durante aprox. 3 segundos

Zero  
Test

Confirmação do balanço zero

comprimento  
de onda

Girar várias as células identificadas com o comprimento de onda selecionado e posicionar no compartimento de medição. Colocar a tampa de cobertura e premir a tecla [Zero/Test].

RESULTADO

pisca durante aprox. 3 segundos



Compara o resultado apresentado com o valor impresso no certificado, tendo em conta as tolerâncias (ver também as indicações no certificado).

Se o resultado estiver fora da tolerância e os padrões estiverem dentro da sustentabilidade, recomenda-se a devolução do aparelho ao fabricante ou comerciante. É conveniente que o fabricante proceda a uma verificação, uma vez que o aparelho é testado não só quanto à calibração mas também quanto a falhas técnicas.

### Kit de padrão de verificação

Os padrões de verificação para o MD 100 / MD 110 / MD 200 destinam-se a verificar a precisão da determinação e a reprodutibilidade dos resultados de medição, relativamente aos comprimentos de onda integrados.

O kit contém uma célula zero e 6 diferentes células de medição para verificação de 6 diferentes comprimentos de onda. O kit padrão de verificação permite, assim, verificar todos os fotômetros das séries MD 100 / MD 110 / MD 200.

A sustentabilidade dos padrões ascende a dois anos a partir da data de fabrico quando o produto é usado e armazenado corretamente. As medições são efetuadas em unidades de mAbs.

Número de ordem	Artigo
21 56 70	Verifikationsstandard-Kit MD 100 / MD 110 / MD 200

**Dados técnicos MD 100, MD 110, MD 200**

Aparelho	selecção automática do comprimento de onda, colorímetro com indicação directa do valor de medição
Optica	EDs, filtro de interferências (FI) e fotossensor na câmara de medição transparente As especificações dos comprimentos de onda dos filtros de interferência dependem da variante do aparelho, máx. 3 comprimentos de onda possíveis comprimentos de onda instalados: 430 nm $\Delta \lambda = 5$ nm 530 nm $\Delta \lambda = 5$ nm 560 nm $\Delta \lambda = 5$ nm 580 nm $\Delta \lambda = 5$ nm 610 nm $\Delta \lambda = 6$ nm 660 nm $\Delta \lambda = 5$ nm
Intervalo fotométrico	-2600 - 2600 mAbs
Precisão do comprimento de onda	$\pm 1$ nm
Exactidão fotométrica*	3 % FS (T = 20 °C – 25 °C)
Resolução fotométrica	0,01 A
Auto-OFF	O aparelho desliga-se automaticamente 10 ou 25 minutos após o último acionamento da tecla (dependendo do método disponível de diferentes tempos de reacção)
Visor	LCD com iluminação de fundo (ao premir as teclas)
Data e hora	Relógio em tempo real e data
Calibração	Calibração de fábrica e do utilizador. Possibilidade de reposição da calibração de fábrica
Condições ambiente	Temperatura: 5–40°C humidade relativa do ar: 30–90 % (não condensada)
Impermeabilidade	Conforme IP 68 (1 hora a 0,1 m); aparelho flutuante
CE	Declaração de conformidade CE sob <a href="http://www.lovibond.com">www.lovibond.com</a>

*\*medido com soluções padrão*



A precisão especificada do sistema de aparelhos só é garantida se forem sempre utilizados os sistemas de reagentes originais, fornecidos pelo fabricante do aparelho.

### **Dados técnicos MD 100**

Alimentação de corrente	4 micropilhas (AAA/LR 03)
Tempo de funcionamento	17 horas de funcionamento ou 5000 medições no modo de funcionamento contínuo com a iluminação de fundo desligada
Memória	Memória circular interna para 16 conjuntos de dados
Interface	Interface de infravermelhos para a transmissão de dados de medição
Dimensões	155 x 75 x 35 mm (C x L x A)
Peso	Aparelho básico, aprox. 260 g (com pilhas)

### **Dados técnicos MD 110**

Alimentação de corrente	4 micropilhas (AAA/LR 03)
Tempo de funcionamento	17 horas de funcionamento ou 5000 medições em modo contínuo com a iluminação de fundo desligada e sem o uso de transferência de dados Bluetooth®.
Memória	Memória circular interna para 125 conjuntos de dados
Interface	Bluetooth® 4.0 para a transferência dos dados de medição armazenados
Módulo de Bluetooth®:	Especificações: Modul: BLE113-A Bluetooth® 4.0 LE FCC ID: QOQBT113 IC: 5123A-BGTBLE113
Dimensões	155 x 75 x 35 mm (C x L x A)
Peso	Aparelho básico, aprox. 260 g (com pilhas)

### **Dados técnicos MD 200**

Alimentação de corrente	4 pilhas (Mignon AA/LR 6)
Tempo de funcionamento	53 horas de funcionamento ou 15.000 medições no modo de funcionamento contínuo com a iluminação de fundo desligada
Memória	Memória circular interna para 16 conjuntos de dados
Interface	Interface de infravermelhos para a transmissão de dados de medição
Dimensões	190 x 110 x 55 mm (C x L x A)
Peso	Aparelho básico, aprox. 455 g (com pilhas)



## Indicações ao utilizador

**Hi**

Gama de medição excedida ou excesso de turvação.

**Lo**

Resultado abaixo da gama de medição.



Substituir a pilha de 9 V, não é possível efectuar mais leituras.

**btLo**

Carga da bateria insuficiente para a iluminação do fundo, medição ainda possível.

Store Date  
Cal Cal  
time RESULTADO Cal

No caso de um método que tenha sido calibrado pelo utilizador, surge ao lado da indicação do resultado no visor uma seta na posição Cal (consultar “Reposição da calibração de fábrica”).

## Mensagens de erro

**E27 / E28 / E29**

Absorção de luz excessiva. Causa, ex.: óptica suja.

**E 10 / E 11**

Factor de calibração fora do intervalo admissível.

**E 20 / E 21**

Sensor recebe demasiada luz.

**E23 / E24 / E25**

Sensor recebe demasiada luz.

**E 22**

Durante a medição, a carga da pilha estava demasiado baixa. Substituir a pilha.

**E 70**

Estas mensagens de erro referem-se a uma calibração de fabrico ou de utilizador errada ou em falta. Entre em contacto com a nossa Assistência Técnica em [techsupport@tintometer.de](mailto:techsupport@tintometer.de).

**E 71**

**E 72**

**:**

- **Belangrijke informatie** . . . . . 139
  
- **Algemene aanwijzingen** . . . . . 140
  - Opmerkingen over de manier van werken met het apparaat . . . . . 140
  - Opmerkingen over de methoden . . . . . 140
  - De cuvet correct vullen . . . . . 141
  - Wisselen van de batterijen . . . . . 142
  
- **Functiebeschrijving** . . . . . 143
  - Ingebruikneming . . . . . 143
  - Scroll Memory (SM) . . . . . 143
  - Stel de nulwaarde in . . . . . 143
  - OTZ (One Time Zero) . . . . . 144
  - Scroll Memory (SM) . . . . . 144
  - Verloop van een meting . . . . . 144
  - Achtergrondverlichting van het display . . . . . 144
  - Countdown / reactietijd . . . . . 145
  - Het uitlezen van opgeslagen gegevens . . . . . 145
  
- **Menu-opties** . . . . . 146
  - Menu openen . . . . . 146
  - Menukeuze . . . . . 146
  - Het uitlezen van opgeslagen gegevens . . . . . 146
  - Verzenden van opgeslagen gegevens - naar printer of PC - bij de MD 100 en MD 200 . . . . . 147
  - Verzenden van opgeslagen gegevens - Bluetooth - bij de MD110 . . . . . 148
  - Instellen van datum en tijd (24 h-formaat) . . . . . 149
  
- **Gebruikersinstelling** . . . . . 150
  - Weergave van de actuele kalibratie instellingen . . . . . 150
  - Gebruikersinstelling . . . . . 150
  - Kalibratiemodus Fluoride . . . . . 152
  - Terugkeren naar de fabrieksinstelling . . . . . 153
  
- **Controle van de meter** . . . . . 154
  - Gebruik van een referentiestandaard set . . . . . 154
  - Gebruik van een verificatiestandaard set . . . . . 155
  
- **Technische gegevens** . . . . . 157
  
- **Instructies voor de gebruiker** . . . . . 159
  
- **Foutmeldingen** . . . . . 159

## Belangrijke informatie voor consumenten in de EU

### Mededeling omtrent afvoer van batterijen en accu's



Ledere verbruiker is op basis van de richtlijn 2006/66/EG verplicht om alle gebruikte batterijen en accu's in te leveren. Het is verboden deze af te voeren via het huisvuil. Aangezien ook onze producten geleverd worden met batterijen en accu's wijzen wij u op het volgende; Lege batterijen en accu's horen niet in het huisvuil thuis. Men kan deze inleveren bij inzamelpunten van uw gemeente of overal daar waar deze verkocht worden. Tevens bestaat de mogelijkheid batterijen en accu's daar in te leveren waar u ze gekocht heeft. (wettelijke terugnameplicht)

### Afvoer van elektronische apparatuur



Volgens deze richtlijn mag elektronische apparatuur niet met het huishoudelijk afval worden afgevoerd. Wij verwijderd uw elektronisch apparaat op een professionele en milieubewuste wijze. Deze service is, exclusief de verzendkosten, gratis en alleen geldig voor elektrische apparatuur die na 13 augustus 2005 is gekocht. Stuur uw te verwijderen Tintometer apparatuur franco aan uw leverancier.

## Veiligheid - Algemene aanwijzingen

De aansprakelijkheid en de garantie van de fabrikant voor schade en gevolgschade vervallen bij een onreglementair gebruik, de niet-naleving van deze handleiding, het inzetten van onvoldoende gekwalificeerd vakpersoneel en een eigenhandige wijziging aan het apparaat. De fabrikant is niet aansprakelijk voor kosten of schade die de gebruiker of een derde oploopt door het gebruik van dit apparaat, vooral bij een ondeskundig gebruik van het apparaat of bij misbruik of storingen van de aansluiting of het apparaat. De fabrikant is niet aansprakelijk in geval van drukfouten.

## Veiligheidsinformatie in de bedieningshandleiding

Deze bedieningshandleiding bevat belangrijke informatie voor de veilige werking van het product. Lees deze bedieningshandleiding volledig door en maak uzelf vertrouwd met het product alvorens u het in werking stelt of ermee werkt. Houd de bedieningshandleiding altijd bij de hand om ze indien nodig te kunnen raadplegen.



### Opmerking:

De beschrijving van de bepalingen alsmede de omgang met de reagentia zijn geen onderdeel van deze gebruiksaanwijzing.

## Opmerkingen over de manier van werken met het apparaat

1. De cuvetten, deksels en de roerstaaf moeten **na elke analyse** grondig worden schoongemaakt om meetfouten door vertraagde reacties te voorkomen. Reeds geringe hoeveelheden achtergebleven reagentia kunnen tot incorrecte metingen leiden.
2. De buitenkanten van de cuvetten moeten schoon en droog zijn alvorens de analyse uit te voeren. Vingerafdrukken of waterdruppels op de lichtdoorlatende oppervlakken van de cuvetten leiden tot incorrecte metingen.
3. Het instellen van de nulwaarde en de test moeten met dezelfde cuvet worden uitgevoerd omdat de cuvetten onderling lichte tolerantieafwijkingen kunnen vertonen.
4. De cuvet moet voor het instellen van de nulwaarde en de test steeds zodanig in de meetschacht worden geplaatst, dat de schaalverdeling met het witte driehoekje in de richting van de markering op de behuizing wijst.
5. Het instellen van de nulwaarde en de test moeten gebeuren wanneer het deksel op de gesloten is. Het deksel van de cuvet moet voorzien zijn van een afdichtring.
6. De vorming van belletjes aan de binnenkant van de cuvet leidt tot incorrecte metingen. In dit geval wordt de cuvet met het bijbehorende deksel gesloten en lost u de belletjes op door de cuvet heen en weer te bewegen alvorens de test uit te voeren.
7. Het binnendringen van water in de meetschacht moet vermeden worden, dit kan leiden tot incorrecte meetresultaten.
8. Vervuiling van de transparante meetschacht zal tot foute meetwaarden leiden. Controleer de transparante meetschacht regelmatig op vervuiling en reinig indien nodig. Voor de reiniging kunt u gebruik maken van vochtige brillendoekjes en wattenstaafjes.
9. Grote temperatuurverschillen tussen fotometer en omgeving kunnen tot foute meetwaarden leiden, b.v. door de vorming van condens in de meetschacht of op het cuvet.
10. Bescherm het toestel tijdens het gebruik tegen directe instraling door zonlicht.
11. De tabletten met reagens moeten direct vanuit de folie aan het watermonster worden toegevoegd zonder ze met de vingers aan te raken.
12. De volgorde waarin de reagentia moeten worden toegevoegd, dient absoluut in acht te worden genomen.

## Opmerkingen over de methoden

- Let op de toepassingsmogelijkheden, analysevoorschriften en matrixeffecten van de methoden.
- Verschillende navulverpakkingen zijn op aanvraag beschikbaar.
- Reagentia zijn bedoeld voor chemische analyse en mogen niet in handen van kinderen terechtkomen.
- Verwijder reagensoplossingen volgens de afvalverwijderingsvoorschriften.
- Vraag indien nodig de veiligheidsinformatiebladen aan.  
(Internet: [www.lovibond.com](http://www.lovibond.com))

**Montage van de afdichting:**

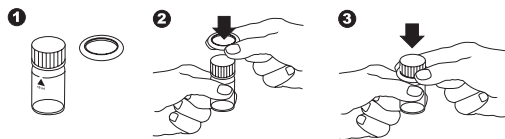

**Opzetten van de afdekkap:**

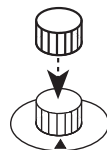

**Positioneren van de adapter:**

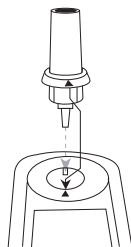

**Positioneren van de adapter:**

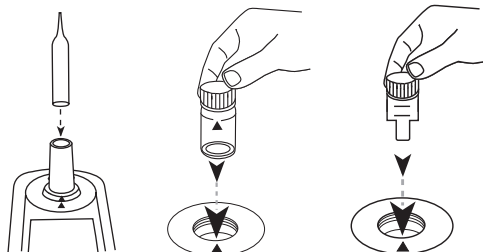

**De cuvet correct vullen:**

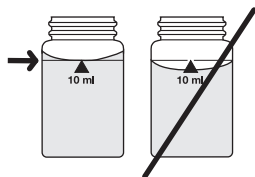

**De juiste handhaving van de reagens:**

**Powder Packs**

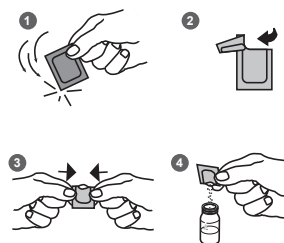

**Vloeibare reagens**



**Blistertabletten**

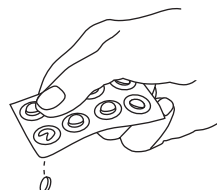

**Wisselen van de batterijen:**

**MD 100 / MD 110**

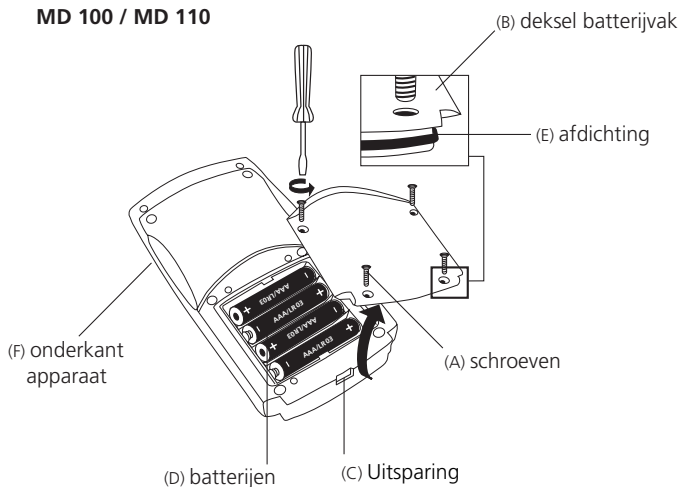

**MD 200**

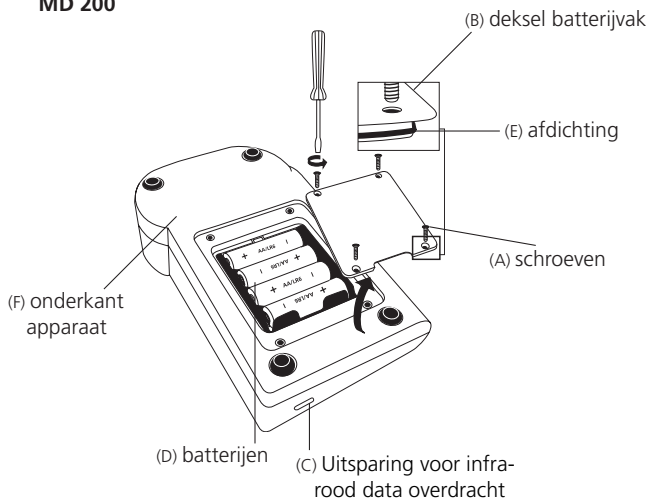

**LET OP:**

**Om een volledige afdichting van de fotometer te kunnen garanderen moet de afdichting (E) gemonteerd en het batterijvakdeksel (B) vastgeschroefd zijn.**

Wanneer de batterijen langer dan 1 minuut uit het toestel worden gehaald, verschijnt nadat de stroomvoorziening hersteld is (plaatsen van de nieuwe batterijen) bij het inschakelen van het toestel automatisch het datum-tijd-programma.

## Ingebruikneming



Apparaat inschakelen



Bepaling kiezen



### Scroll Memory (SM)

Bij multiparameter apparaten is de volgorde van de verschillende bepalingen vastgelegd. Na het inschakelen van de fotometer wordt automatisch de laatst gebruikte bepaling voor het uitschakelen van de fotometer weergegeven. Dit maakt een snellere toegang tot de meest gebruikte bepalingen mogelijk.



### Opmerking:

De beschrijving van de bepalingen en de omgang met de reagentia zijn geen onderdeel van deze gebruiksaanwijzing, ze staan in een apart document.

### Fluoride bepaling

#### Let op!



Voor de eerste inbedrijfname moet een afstelling van de bepaling worden uitgevoerd (zie ▼ kalibratie modus Fluoride). Voor de afstelling en het meten van monsters moet men dezelfde batch SPADNS reagensoplossing gebruiken. De afstelling van de meter dient men voor iedere nieuwe batch SPADNS reagensoplossing uit te voeren.



### Stel de nulwaarde in

24 mm cuvet met 10 ml monster vullen

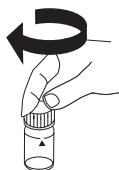

Cuvet afsluiten



Monstercuvet in de meetschacht zetten

Let op de positionering

Sample



Druk op de toets [Zero/Test]

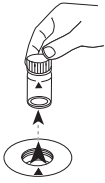

Haal de cuvet uit de meetschacht

**OTZ (One Time Zero)**

One Time Zero is voor alle fotometer varianten verkrijgbaar waarbij de nulstelling in een 24 mm rond cuvet met monsterwater wordt uitgevoerd. Hij kan worden gebruikt als verschillende tests onder dezelfde testomstandigheden met hetzelfde watermonster worden uitgevoerd. Bij wisseling van de bepaling is het dan niet meer noodzakelijk om opnieuw een nulpunt in te stellen; er kan direct met de test worden begonnen. Het nulpunt blijft tot uitschakeling van het apparaat opgeslagen.

Een nieuwe nulpuntsinstelling kan indien gewenst op elk moment worden uitgevoerd.



One Time Zero (OTZ), 1 x instelling nulpunt uitvoeren, daarna meting van de parameter



Nieuw nulpunt instellen, toets gedurende 2 seconden indrukken

**Verloop van een meting**



Reagens (b.v. een reagenstablet) toevoegen (zie beschrijving van de methode)

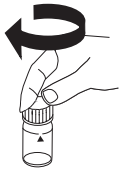

Cuvet afsluiten



Monstercuvet in de meetschacht zetten  
Let op de positionering



Druk op de toets [Zero/Test]

**Achtergrondverlichting van het display**



indrukken, tijdens de meting volgt automatische uitschakeling



## Countdown / reactietijd

Bij bepalingen met een reactietijd bestaat de mogelijkheid om, tijdens het uitvoeren van de test, een count-down-functie in te schakelen.



indrukken en vasthouden



indrukken



loslaten

Countdown/reactietijd loopt, de meting start automatisch na afloop van de tijd.



Countdown/reactietijd afbreken



### Let op:

**Het niet in acht nemen van reactietijden kan leiden tot incorrecte meetresultaten.**

### Opmerking:

De beschrijving van de bepalingen en de omgang met de reagentia zijn geen onderdeel van deze gebruiksaanwijzing, ze staan in een apart document.



## Het uitlezen van opgeslagen gegevens

De meter beschikt over een ringgeheugen. De 16 laatste meetwaarden zijn op te roepen.



meter inschakelen



meer dan 4 seconden ingedrukt houden, daarna loslaten, om direct in het geheugenmenu te komen



door meetgegevens scrollen



herhalen van de meetgegevens



terug naar de meetmodus

Uitlezing in volgend formaat (regel voor regel in automatische volgorde, 3 seconden per regel, tot weergave van het meetresultaat):

Doorlopend Nummer	n xx (xx: 16...1)
Jaar	YYYY (bijv. 2014)
Datum	MM.dd (MaandMaand.DagDag)
Tijd	hh:mm (UurUur:MinuutMinuut)
Methode	Methode-symbol
Resultaat	x,xx

### Menu openen

Apparaat is uitgeschakeld



indrukken en **vasthouden**



kort indrukken, loslaten



loslaten

### Menukeuze

indrukken, om menupunt te kiezen ("scrollen")



Keuze uit volgende menupunten:

- diS Uitlezen van opgeslagen gegevens
- Prt Printen van de opgeslagen gegevens
- Instellen van datum en tijd
- Gebruikersinstelling

of



afhankelijk van  
apparaatuitvoering

Het geselecteerde menuonderdeel wordt weergegeven door een pijltje op het display.

### diS – Het uitlezen van opgeslagen gegevens

Menu openen (zie "Menu openen")

door meetgegevens scrollen



Herhalen van de meetgegevens



Terug naar de meetmodus



De meter beschikt over een ringgeheugen. De 16 laatste meetwaarden zijn op te roepen.



Uitlezing in volgend formaat (regel voor regel in automatische volgorde, 3 seconden per regel, tot weergave van het meetresultaat):

Doorlopend Nummer	n xx (xx: 16...1)
Jaar	YYYY (bijv. 2014)
Datum	MM.dd (MaandMaand.DagDag)
Tijd	hh:mm (UurUur:MinuutMinuut)
Methode	Methode-symbol
Resultaat	x,xx

Store Date  
▲ Prt  
Time Cal

**▲ Prt – Verzenden van opgeslagen gegevens  
- naar printer of PC  
- bij de MD 100 en MD 200**



**LET OP:** voor het verzenden van opgeslagen gegevens naar een printer of PC heeft u de, als optie verkrijgbare, infraroodgegevensverzendsmodule (IRiM) nodig. Deze kan in combinatie met de apparaten MD 100 en MD 200 worden gebruikt.

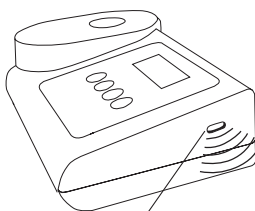
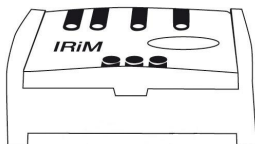

Uitsparing voor infra-  
rood data overdracht

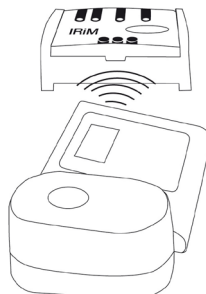

**PrtG**



**On  
Off**



**E 162**

Menu openen (zie "Menu openen")

indrukken

De IRiM en benodigde randapparatuur dienen gebruiksklaar te zijn. De meter geeft gedurende ca. 1 seconde de melding "PrtG" (printing).

indrukken

Aansluitend wordt het nummer van het eerste gegevensbestand getoond en worden deze gegevens verzonden. Daarna worden vervolgens alle opgeslagen gegevensbestanden verzonden. Hierna gaat de meter weer in de meetmodus.

Het printen kan worden onderbroken door de toets [On/Off] te drukken. De meter wordt uitgeschakeld.

Als er geen communicatie met de IRiM mogelijk is dan zal er na ca. 2 minuten een time-out optreden. Gedurende ca. 4 seconden wordt foutcode E 132 getoond waarna de meter weer naar de normale meetmodus gaat (zie ook de IRiM gebruiksaanwijzing).



## **Prt – Verzenden van opgeslagen gegevens - Bluetooth - bij de MD110**

De MD 110 beschikt over een Bluetooth 4.0 interface, deze maakt een draadloze overdracht van meetgegevens mogelijk. Bluetooth 4.0 staat ook bekend als Bluetooth Smart of Bluetooth LE (Low energy). De gegevens worden vanuit de fotometer in .csv format overdragen. Een omschrijving van de door de fotometer overdragen informatie kan men downloaden via [www.lovibond.com](http://www.lovibond.com). Voor de data ontvangst heeft de Tintometer GmbH diverse oplossingen beschikbaar.

Voor mobiele apparatuur staat de app AqualX® ter beschikking, deze beheert de ontvangen data en geeft ze grafisch weer. Zowel data als grafieken kunnen direct per e-mail worden doorgestuurd. AqualX® kan men voor iOS® in de iTunesStore® en voor Android™ in de Google Play™ Store gratis downloaden.

Een softwaretool maakt de ontvangst van de op de fotometer opgeslagen data op een PC mogelijk. Deze data kan men naar een Excel® sheet exporteren waar hij op de gewone wijze verder kan worden gebruikt. Mocht er geen Excel® voorhanden zijn dan kan men de data alternatief als .txt opslaan, daarmee staan ze later voor verdere verwerking klaar. Voor de ontvangst van de data heeft men de met de software meegeleverde Bluetooth® dongle nodig.

Artikel	Bestelnr.
Software, inclusief Bluetooth® Dongle	2444480

Menu openen (zie "Menu openen ")



indrukken



indrukken

De randapparatuur moet gebruiksklaar zijn

De meter geeft de status van de Bluetooth® verbinding aan.

In de display verschijnt: "ncon" (not connecting).

Er kan een actualisering van de lijst herkende apparaten in de software van het randapparaat nodig zijn, zie daarvoor de gebruiksaanwijzing van de AqualX® of de data transfer software van de Bluetooth® Dongle.

In de display verschijnt: "con" (connecting).



Door de (MODE)-toets te drukken wordt de dataoverdracht gestart; in de display verschijnt gedurende de opbouw van de verbinding en de dataoverdracht "PtrG" (printing).

Een voor een worden de verschillende opgeslagen datasets verzonden.

De meetresultaten blijven opgeslagen op de fotometer.

Na afloop schakelt het apparaat in de meetmodus en de Bluetooth verbinding wordt onderbroken.



De dataoverdracht kan op elk moment worden onderbroken door de toets (On/Off) te drukken.

De meter wordt uitgeschakeld.



## **2 3** Instellen van datum en tijd (24 h-formaat)

Menu openen (zie "menu openen")



2 x drukken = pijlsymbool op Time & Date



bevestigen



waarde verhogen



waarde verlagen



de gekozen instelling bevestigen



in de display verschijnt "IS SET" na de laatste bevestiging.

De meter gaat nu automatisch naar de meetmodus.

## Weergave van de actuele kalibratie instellingen

Menu openen (zie "Menu openen")

3x = pijlsymbool op CAL of CAL in de display

bevestigen

Afwisselend verschijnt in de display: CAL/"Methode".



CAL

BEPALING

cAL

CAL

### Toelichting:

Gebruikersinstelling

Fabrieksinstelling



## 4 Gebruikersinstelling

Menu openen (zie "Menu openen")

3x = pijlsymbool op CAL of CAL in de display

bevestigen

Afwisselend verschijnt in de display: CAL/"Methode".



CAL

BEPALING



Methode kiezen



24 mm cuvet met 10 ml monster vullen

Het monster dient water zonder kleur en troebelheid te zijn (b.v. demi water, zuiver drinkwater)

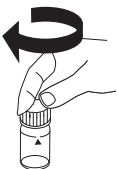

Cuvet sluiten

## NL Gebruikersinstelling



Cuvet in de meetschacht plaatsen  
Let op de positionering



indrukken

≡ BEPALING ≡

knippert ca. 8 seconden

0.0.0

CAL

De bevestiging van de nulstelling 0.0.0 verschijnt afgewisseld met CAL.



De meting uitvoeren met een standaard met bekende concentratie.

indrukken

≡ BEPALING ≡

knippert gedurende ca. 3 seconden

RESULTAAT

CAL

Het resultaat verschijnt afgewisseld met CAL.

Komt de meetwaarde overeen met de waarde van de gebruikte standaard (met inachtneming van de geldende toleranties), dan kunt u de kalibratiestand verlaten.



indrukken

Komt de meetwaarde niet overeen met de waarde van de gebruikte standaard (met inachtneming van de geldende toleranties), dan kunt u de meetwaarde veranderen:



1 x drukken verhoogt de meetwaarde met 1 digit.



1 x drukken verlaagt de meetwaarde met 1 digit.

Druk de toetsen tot de meetwaarde in de display met de waarde van de standaard overeenkomt.

CAL

RESULTAAT + x

De meetwaarde verschijnt afwisselend met CAL.



Langer dan 4 seconden ingedrukt houden

De gebruikerskalibratie is afgesloten en opgeslagen.

### 4 Kalibratiemodus Fluoride

Kalibratie uitvoeren met:

0 mg/l en 1 mg/l F- standaard en een schoon cuvet  
(zie methodebeschrijving, opm.)

#### Kalibratie Fluoride:

Menu openen (zie "Menu openen")



3x = pijlsymbool op Cal of Cal in de display  
bevestigen



Na bevestiging van de keuze met de toets (MODE) verschijnt afwisselend in de display: CAL/F.

Doe 10 ml demi-water in een schoon cuvet en sluit deze met het deksel.

Zet het cuvet in de meetschacht. Positionering  $\bar{X}$ .



Druk de (ZERO/TEST) toets.

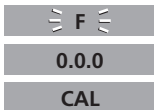

Het parameter symbool knippert ca. 8 seconden.

De bevestiging van de nulstelling 0.0.0 verschijnt afgewisseld met CAL.

Voeg **exact 2 ml SPADNS reagensoplossing** toe aan de 10 ml demiwater. Sluit het cuvet goed met het cuvetdeksel en meng de inhoud door het cuvet te zwenken.

Zet het cuvet in de meetschacht. Positionering  $\bar{X}$ .



Druk de (ZERO/TEST) toets.



Het parameter symbool knippert ca. 3 seconden.

In de display verschijnt:

Neem het cuvet uit de meetschacht, reinig cuvet en cuvetdeksel grondig en vul het cuvet met **exact 10 ml Fluoride standaard (concentratie 1 mg/l F)**.

Voeg **exact 2 ml SPADNS reagensoplossing** toe aan de 10 ml Fluoride standaard. Sluit het cuvet goed met het cuvetdeksel en meng de inhoud door het cuvet te zwenken.

Zet het cuvet in de meetschacht. Positionering  $\bar{X}$ .



Druk de (ZERO/TEST) toets.



Het parameter symbool knippert ca. 3 seconden.



## NL Gebruikersinstelling

F1



:

In de display verschijnt:

Door de toets (ON/OFF) in te drukken wordt de nieuwe kalibratie opgeslagen.

In de display verschijnt gedurende 3 seconden de bevestiging van de kalibratie.

### Terugkeren naar de fabrieksinstelling

Terugkeren van de gebruikersinstelling naar de fabrieksinstelling is alleen maar mogelijk voor alle methoden tegelijk.

Bij een bepaling, die door de gebruiker gekalibreerd werd, wordt in de display naast de meetwaarde een pijl op de positie CAL of CAL in de display weergegeven.

Om de meter weer in de fabriekskalibratie terug te zetten gaat men als volgt te werk:



SEL

CAL

indrukken en **beide ingedrukt houden**

kort drukken, loslaten

na ca. 1 seconde toetsen loslaten

In de display verschijnt afwisselend:  
fabriekskalibratie

SEL

cAL

**of:**  
gebruikerskalibratie

Mode

Door indrukken wordt de fabriekskalibratie voor alle bepalingen geactiveerd.

SEL

CAL

In de display verschijnt afwisselend:



Schakel de meter uit



**Gebruik van een referentiestandaard set (zie ook pagina 19 referentiestandaard sets voor MD 100, MD 110 en MD 200)**

Kies volgens de gebruiksaanwijzing de gewenste bepaling rekening houdend met het gebruikte reagenssysteem (tablet, vloeibare reagens of Powder Packs).

Bij gebruik van vloeibare reagens dient men de tablettenmethode te kiezen.



Meter inschakelen.



Bepaling kiezen.

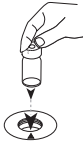

Referentiestandaard "Zero" cuvet in de meetschacht plaatsen.  
Let op de positionering.

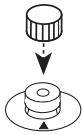

Afdekkapje plaatsen.



De toets (ZERO/TEST) indrukken.

**0.0.0**

Bevestiging van de nulstelling.

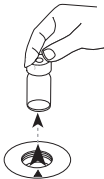

Cuvet uit de meetschacht nemen.



Referentiestandaard voor de gekozen bepaling in de meetschacht plaatsen.  
Let op de positionering.



De toets (ZERO/TEST) indrukken.

**RESULTAAT**

Het resultaat wordt vergeleken met de op het test-certificaat vermelde waarde, met inachtneming van de toleranties (standaard & meter). Let



op de juiste combinatie met het gekozen reagenssysteem!

Mocht het resultaat buiten de toleranties liggen controleer dan de houdbaarheid van de standaard en of de meter wel op de fabriekskalibratie staat.

Mocht dit het geval zijn dan wordt aangeraden om de meter terug te sturen naar de fabrikant of de leverancier.

### Referentiestandaard sets voor de MD 100, MD 110 en de MD 200

De referentie standaarden worden uitsluitend gebruikt om de meetnauwkeurigheid van de in het testcertificaat genoemde fotometers te controleren.

De kalibratie (afstelling) van deze apparaten is onder normale omstandigheden gedurende zeer lange tijd stabiel. De fotometer kan niet met de referentiestandaarden worden gekalibreerd.

De referentiestandaarden worden in vast verzegelde cuvetten geleverd.

De meetwaarde voor elke standaard zijn in het certificaat vermeld.

De houdbaarheid van de referentiestandaarden bedraagt 2 jaar vanaf productiedatum bij juist gebruik en opslag.

Cuvetten voor gebruik altijd met een schone doek reinigen.

Bestelnr.	Artikel	Meetbereik
275650	<b>Set chloor</b> voor meters met tabletten-/vloeibare reagens	0,2* + 1,0* mg/l
275655	<b>Set chloor</b> voor meters met tabletten-/vloeibare reagens	0,5* + 2,0* mg/l
275656	<b>Set chloor</b> voor meters met tabletten-/vloeibare reagens	1,0* + 4,0* mg/l
275660	<b>Set chloor</b> voor meters met tabletten-/vloeibare reagens	0,2* + 1,0* mg/l
275670	<b>Set chloor</b> voor meters met tabletten-/vloeibare reagens	7,45* pH

\* Richtwaarde, exacte waarde volgens analysecertificaat.

### Gebruik van een verificatiestandaard set (zie ook verificatiestandaard set, pagina 154)



indrukken en **vasthouden**



kort indrukken, loslaten



loslaten.

## NL Controle van de meter

AbS

A530

In de display verschijnt kortstondig:  
AbS afgewisseld met de te meten golflengte (b.v. A530 voor 530 nm).

Mode

Bij meters met meerdere LEDs de gewenste golflengte middels meermaals drukken van de toets (Mode) kiezen (scrollen).

Zero  
Test

Het met "Zero" gekenmerkte cuvet in de meetschacht positioneren. Plaats het afdekkapje en druk de (Zero/Test) toets.

GOLFLENGTE

knippert ca. 3 seconden

0.0.0

bevestiging van de nulstelling

Zero  
Test

Het met de gekozen golflengte gekenmerkte cuvet meermaals omzwenken en in de meetschacht positioneren. Plaats het afdekkapje en druk de (Zero/Test) toets.

GOLFLENGTE

knippert ca. 3 seconden

RESULTAAT

Vergelijk de waarde op de display met de op het certificaat vermelde waarde met inachtneming van de toleranties (zie ook opmerking op certificaat).



Ligt het resultaat buiten de toleranties en zijn de standaarden binnen de houdbaarheidstermijn raden wij aan om de meter terug te sturen naar de fabrikant of leverancier. De controle door de fabrikant is zinvol omdat de meter, naast de kalibratie, ook op technische defecten wordt gecontroleerd.

### Verificatiestandaard set

De verificatiestandaardenvoor de MD 100 / MD 110 / MD 200 dienen ter controle van de meetnauwkeurigheid en de reproduceerbaarheid van meetresultaten, betrekking hebbende op de geïntegreerde golflengten.

De set bevat een "Zero" cuvet en 6 verschillende meetcuvetten ter controle van 6 verschillende golflengten. De verificatiestandaard set maakt de controle van de verschillende MD 100 / MD 110 / MD 200 fotometers mogelijk.

De standaarden zijn 2 jaar houdbaar bij juist gebruik en opslag. De metingen worden weergegeven in mAbs eenheden.

Bestelnr	Artikel
21 56 70	Verificatiestandaard set MD 100 / MD 110 / MD 200

**Technische gegevens MD 100, MD 110, MD 200**

Apparaat	automatische keus van de golflengte Colorimeter met directe uitlezing van de meetwaarde
Optiek	LED's, interferentiefilter (IF) en fotosensor aan een transparante meetschacht. Golflengtespecificaties van de interferentiefilters is afhankelijk van de apparaatuitvoering, max. 3 golflengten. <u>Mogelijk</u> ingebouwde golflengten: 430 nm $\Delta \lambda = 5$ nm 530 nm $\Delta \lambda = 5$ nm 560 nm $\Delta \lambda = 5$ nm 580 nm $\Delta \lambda = 5$ nm 610 nm $\Delta \lambda = 6$ nm 660 nm $\Delta \lambda = 5$ nm
Bereik fotometer	-2600 - 2600 mAbs
Tolerantie van de golflengte	$\pm 1$ nm
Fotometrische nauwkeurigheid*	3 % FS (T = 20 °C – 25 °C)
Resolutie fotometer	0,01 A
Auto-OFF	Automatische uitschakelfunctie 10 tot 20 minuten nadat voor het laatst op een toets is gedrukt (per beschikbare methode verschillende reactietijden)
Display	LCD met achtergrondverlichting (via toets)
Tijd	real-time klok en datum
Kalibratie	Fabrieks- en gebruikerskalibratie. Terugkeer naar fabriekskalibratie mogelijk.
Omgevingscondities	Temperatuur: 5–40 °C rel. luchtvochtigheid: 30–90% (niet condenserend)
Waterdicht	conform IP 68 (1 uur bij 0,1 meter); apparaat drijft
CE	Certificaat CE conformiteit via <a href="http://www.lovibond.com">www.lovibond.com</a>

*\*gemeten met standaardoplossingen*



De in de specificaties opgegeven nauwkeurigheid van het systeem wordt alleen maar bereikt wanneer de door de fabrikant meegeleverde originele reagentiasystemen worden gebruikt.

### Technische gegevens MD 100

Voeding	4 microbatterijen (AAA/LR 03)
Bedrijfsduur	17 h uur c.q. 5000 metingen bij duurttest met-uitgeschakelde displayverlichting
Geheugen	Intern ringgeheugen voor 16 gegevensbestanden
Schnittstelle	IR-Schnittstelle für Messdatenübertragung
Afmetingen	155 x 75 x 35 mm (L x B x H)
Gewicht	Meter ca. 260 gram (incl. batterijen)

### Technische gegevens MD 110

Voeding	4 microbatterijen (AAA/LR 03)
Bedrijfsduur	17 h uur c.q. 5000 metingen bij duurttest met-uitgeschakelde displayverlichting en zonder ingeschakelde Bluetooth® dataoverdracht
Geheugen	Intern ringgeheugen voor 125 gegevensbestanden
Schnittstellen	Bluetooth® 4.0 für die Übertragung gespeicherter Messdaten
Bluetooth® module:	specificaties: Modul: BLE113-A Bluetooth® 4.0 LE FCC ID: QOQBT113 IC: 5123A-BGTBLE113
Afmetingen	155 x 75 x 35 mm (L x B x H)
Gewicht	Meter ca. 260 gram (incl. batterijen)

### Technische gegevens MD 200

Voeding	4 batterijen (Mignon AA/LR 6)
Bedrijfsduur	53 h uur c.q. 15000 metingen bij duurttest met-uitgeschakelde displayverlichting
Geheugen	Intern ringgeheugen voor 16 gegevensbestanden
Schnittstelle	IR-Schnittstelle für Messdatenübertragung
Afmetingen	190 x 110 x 55 mm (L x B x H)
Gewicht	Meter ca. 455 gram (incl. batterijen)

## Instructies voor de gebruiker

**Hi**

Meetbereik overschreden of troebeling te sterk.

**Lo**

Meetbereik onderschreden.



Batterijen onmiddellijk vervangen, verder werken niet mogelijk.

**btLo**

Spanning van de batterij te laag voor achtergrondverlichting display. Meting wel mogelijk.

Store Date  
Cal **RESULTAAT** Cal  
Time

Bij een methode die door de gebruiker gekalibreerd werd, staat bij het meetresultaat in de display een pijl bij Cal (zie: terugzetten naar fabriekskalibratie).

## Foutmeldingen

**E27 / E28 / E29**

Lichtabsorptie te groot. Oorzaak bijv.: optisch element vuil.

**E 10 / E 11**

Inregelfactor buiten het toegestane bereik.

**E 20 / E 21**

Detector krijgt te veel licht.

**E23 / E24 / E25**

Detector krijgt te veel licht.

**E 22**

Tijdens de meting was het vermogen van de batterij te laag. Vervang de batterijen.

**E 70**

Deze foutmeldingen duiden op een defecte of niet aanwezige fabrieks- of gebruikerskalibratie. Neem a.u.b. contact op onze technische ondersteuning via [techsupport@tintometer.de](mailto:techsupport@tintometer.de).

**E 71**

**E 72**

**:**

• 重要信息 .....	161
• 一般注意事项 .....	162
光度计测试使用指南 .....	162
安装定位环 .....	163
安装密封盖 .....	163
定位适配器 .....	163
定位比色管 .....	163
水样的正确装填方式 .....	163
试剂的正确操作方式 .....	163
更换电池 .....	164
• 功能说明 .....	165
操作 .....	165
自动记忆(SM) .....	165
调零 .....	165
OTZ (一次调零) .....	166
试剂操作 .....	166
显示背光 .....	166
倒计时/反应时间 .....	167
查阅存贮的数据 .....	167
• 菜单描述 .....	168
进入菜单 .....	168
菜单选择 .....	168
查阅存贮的数据 .....	168
把存贮的数据传送到： - 电脑或打印机 - MD 100 ， MD 200的屏幕上 .....	169
通过蓝牙接口 - Bluetooth® - 传送存贮的数据 ( MD 110 ) .....	170
设置时间和日期 (24-小时 格式) .....	171
• 用户自定义校正 .....	172
显示当前的校正数据 .....	172
用户自定义校正 .....	172
氟离子测试的校正模式 .....	174
复位工厂校正 .....	175
• 检测仪器性能 .....	176
请选购专门针对MD100, MD110和MD200仪器开发的标样套装来检测仪器的性能 .....	176
用标样来检测仪器的性能 .....	177
• 技术参数 .....	179
• 故障代码 .....	181



## 欧盟区的用户请留意以下重要信息

### 电池和蓄电池的重要处理说明



EC Guideline 2006/66 / EC要求用户退回所有旧的和损耗的电池和蓄电池。不得将其丢弃在普通的生活垃圾中。由于我们的产品包括电池/蓄电池，我们的建议如下：废弃的电池和蓄电池不属于生活垃圾，必须妥善处理。您当地有专门的回收机构，也可以拿到购买的地方让店主代为处理。也可以拿到电池厂商固定的回收点处理。厂商有义务处理废弃的电池。



### 电子设备的处理



欧盟标准2012/19/EU 规定禁止按一般的生活垃圾来处理用过的电子设备。请用专业且环保的方式处理。我们公司针对在2005年8月13日以后购买的仪器有提供免费的回收服务，但运费需要您支付。请把用过的仪器送到您的经销商就行了。



## 安全性 - 通用说明

如果用户被发现有以下违规操作，仪器将不能享受免费质保。这些操作包括：不正确使用仪器，不按本手册的说明操作仪器，操作员没有获得相关资质就去操作仪器，以及违规改变仪器等。对于使用本仪器时对用户或第三方造成的损失，我们不用承担相关的法律责任，特别是违规使用仪器时。对于打印错误，我们也不承担相关责任。

## 本手册的安全提示信息

本手册提供了许多有关安全操作仪器的重要信息，请在使用仪器之前详细阅读本手册。请把手册放在仪器附近，以备不时之需。



### 注意：

本手册没有包括试剂的操作规程，操作规程另外提供，您也可以在我们的官网上免费下载。

## 光度计测试使用指南:

1. 每次测试后，应彻底清洁样品比色皿，瓶盖和搅拌棒，以防止干扰。即使是少量试剂残留也会导致测试结果出错。
2. 每次测试前，比色皿外壁必须洁净、干燥。用无纤维毛巾清洁小瓶外部，以去除指纹或其他污迹。
3. 零点校准和测试必须使用相同的样品比色皿进行，因为样品比色皿之间的光学性能可能略有差异。
4. 进行零点校准时，请确保比色皿位于比色池中，并使比色皿方向对准仪器上的标记。
5. 进行零点校准和样品测试时，务必保证比色池盖子已经盖好，并且使用带密封圈的盖子。
6. 比色皿内壁上的气泡会导致测试不正确。为防止这种情况，请在进行测试前，可轻轻旋转比色皿去除气泡。
7. 避免水样溢入比色池，因为这会导致不正确的测试结果。
8. 比色池污染将导致测试误差，应定期检查并清洁，并保持干燥。
9. 仪器和环境之间的温差很大可能导致测试错误 - 例如在比色池或比色皿表面形成冷凝，影响测试。
10. 为避免杂散光造成的错误，请勿在强光下使用本仪器。
11. 禁止用手指直接接触药丸试剂，请捏住试剂铝箔包装把药丸挤到水样中。
12. 请确保试剂添加次序正确。

## 测试方法指南：

- 确认测试样品适合本分析方法进行测试（无测试干扰），并无需任何样品前处理（如调节pH,过滤等）。
- 有需要时可以选购可添加的试剂。
- 试剂仅用于化学分析，应远离儿童的触及范围。
- 确保妥善处理试剂溶液。
- 材料安全数据表（MSDS-Material Safety Data Sheets）可于官网查询（[www.lovibond.com](http://www.lovibond.com)）

## CN 注意事项

安装定位环：



安装密封盖：

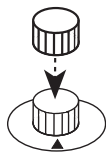

定位适配器：

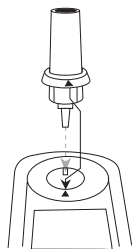

定位比色管：

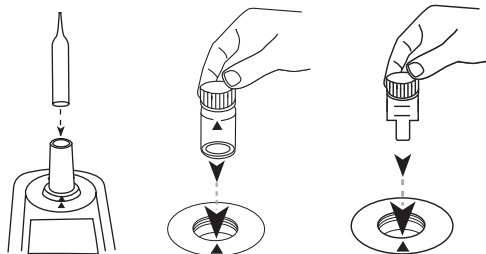

水样的正确装填方式：

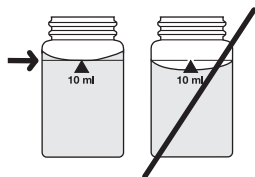

试剂的正确操作方式：

粉末包：

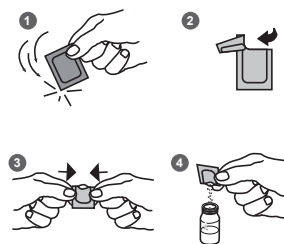

液体试剂

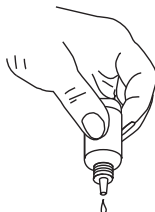

锡箔药丸试剂

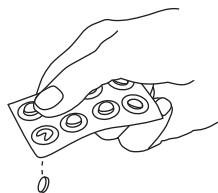

**更换电池:**

**MD 100 / MD 110**

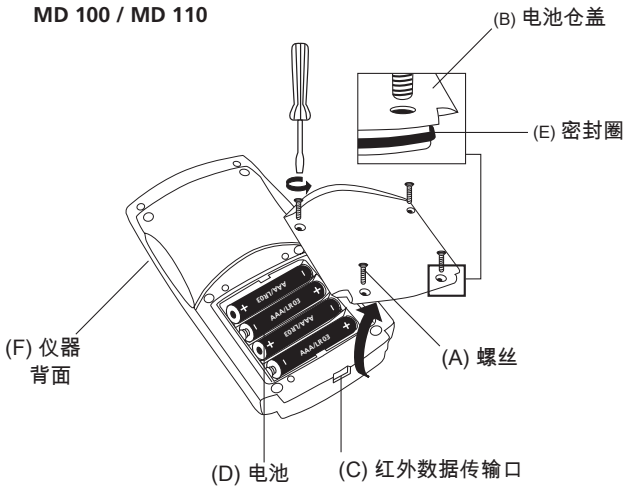

**MD 200**

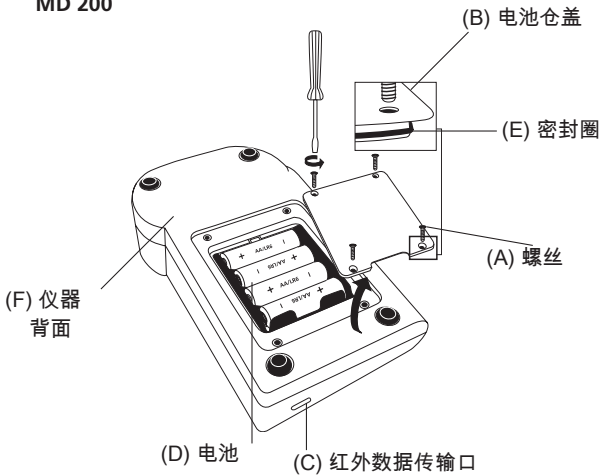

**注意：**

为确保仪器的防水性能：

- 密封圈(E)必须安装到位
- 必须用四个螺丝固定好电池保护盖(B)

如果电池移除超过1分钟,光度计下一次开启时,将自动进入日期时间设置菜单。需要重新设置日期时间。

## 操作



开机



选择测试方法



### 自动记忆(SM)

为了避免不必要的滚动选择菜单，关机前仪器会自记录最后一次测试方法。当再次开机后，上次关机前记录的最的一个测试方法将自动显示在第一位。



注意：

本手册不提供试剂的操作规程，请查阅另外单独提供的文件。



### 氟离子测试

注意：

在第一次使用时，需要校正（参阅 ▼ 氟离子的校正模式）。在调节和测试时必须使用同一批次的SPADNS试剂。换了批次后必须重新再调节一次。

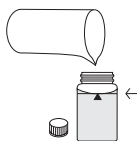

### 调零

往24 mm比色瓶加10 ml水样。

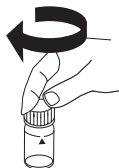

旋紧瓶盖。



把比色瓶插入插槽。  
注意比色瓶的位置方向。



按一下 [ZERO/TEST] 键。



从插槽中取出比色管。

### OTZ (一次调零)

开机后，只需要调零一次，就可以测试了。调零时用的是实际的水样和24 mm的比色管。只要测试条件和水样没有改变，就可以一直使用零点数据。切换到其它测试参数时也不需要重新调零，可以马上测试。关机后，零点数据就会失效。

必要时可以再测试零点一次。



One Time Zero (OTZ)，指的是1次调零，再测试。



按住零点键2秒，再测试一次零点。

### 试剂操作

加入相关的试剂 ( 参阅试剂操作规程 ) 。

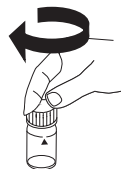

旋紧盖子。



插入比色管。  
注意比色管的位置方向。 .



按一下 [ZERO/TEST]键。

### 显示背光



按一下该键后，在测试过程中自动关闭背光，以节省电量。

## 倒计时/反应时间

对于需要反应一段时间的试剂来说，我们有提供倒计时的功能。



- 按住
- 按一下
- 再松开



自动开始倒计时，时间到了自动启动测试。

中断倒计时：

**注意：**  
不正确激活倒计时功能会导致错误的测试结果。

**注意：**

本手册不提供试剂的操作规程，请查阅另外单独提供的文件。



## 查阅存贮的数据

可以查阅过去16次的测试结果。

开机。

按住4秒，再松开，就进入查阅菜单了。

翻阅测试结果。

再查一次测试结果。

返回到测试模式。



按以下格式自动每3秒切换显示，直到显示最终的测试结果。

数字	n xx (xx: 16...1)
年	YYYY (例如2014)
日期	mm.dd (月：日)
时间	hh:mm (小时：分钟)
测试	测试方法
结果	x.xx

## 进入菜单

设备已关闭



一直按住该键



轻按该键再松开



再松开该键

## 菜单选择

按一下该键，选择一个子菜单（滚动选择）

有以下4个子菜单：

▲ diS 查阅存贮的数据

▲ Prt 打印存贮的数据

▲ ▾ 设置日期和时间

▾ 用户自定义校正

屏幕显示的箭头方向代表了不同的子菜单。

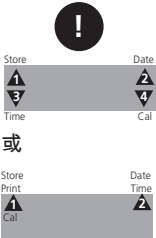

取决于不同的测试参数

## ▲ diS – 查阅存贮的数据

进入菜单 (参阅“进入菜单”)

滚动选择数据组

再查看一次当前的数据组

返回测试状态

仪器配的是环形存贮器，可查阅最近16次的测试数据。

按以下格式自动每3秒切换显示，直到显示最终的测试结果。

数字	n xx (xx: 16...1)
年	YYYY (例如2014)
日期	mm.dd (月：日)
时间	hh:mm (小时：分钟)
测试	测试方法
结果	x.xx





Store Date  
▲ Prt  
Time Cal



- ▲ Prt – 把存贮的数据传送到：
- 电脑或打印机
  - MD 100 ， MD 200的屏幕上

注意：要把数据打印出来或传送到电脑上，必须另外选购一个红外接口配件IRiM。该配件可以跟MD100和MD200兼容。

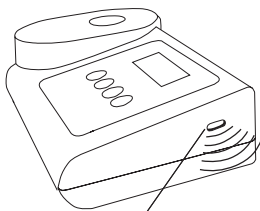
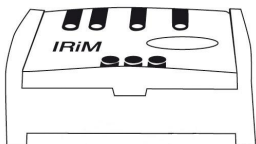

红外数据传输口

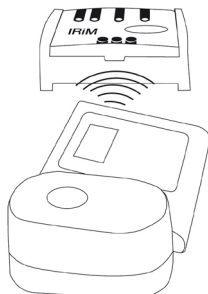

PrtG

Mode

On  
Off



E 162

进入菜单（参阅“进入菜单”）

按一下该键

外接设备（红外接口配件，电脑和打印机）必须准备就绪。仪器显示“PrtG”（打印中）字样约1秒。

按一下该键

所有数据按次序发送，完成后仪器返回测试状态。

打印中途可以按On/Off键强行中断打印，仪器关机。

如果在2分钟内没有检测到IRiM红外接口配件，会显示E132字样约4秒，然后仪器自动返回到测试状态。（另请参阅IRiM配件说明书）。



**▲ Prt – 通过蓝牙接口 - Bluetooth®  
– 传送存贮的数据 ( MD 110 )**

MD 110具有蓝牙4.0接口，可以通过无线的方式传送数据。现在可以传输存储的数据了。蓝牙®4.0有2种规范，分别是蓝牙®智能或蓝牙®LE（低能耗）。传送的数据为.csv文件格式。有关如何从光度计传输信息的详细信息，请访问[www.lovibond.com](http://www.lovibond.com)。要接收数据，Tintometer集团公司提供了几个选项。

aqualx®可用于智能手机和平板电脑等移动设备，使用户能够管理接收到的数据并以图表的形式表示出来。然后可以通过电子邮件共享数据和图表。Aqualx®可以从iOS®的iTunes Store®和Android™的Google Play™Store免费下载。

电脑端可以安装一个软件来接收光度计上存储的数据。数据可以导出到Excel®电子表格中，使用户可以根据其使用习惯来分析数据。如果Excel®不可用，则可以将数据存储为.txt文件，以便日后处理。软件标配了一个蓝牙加密狗。

说明	货号
电脑软件包括蓝牙加密狗	2444480



进入菜单（参阅“进入菜单”）

按一下该键

再按一下该键

外接设备请准备就绪。

屏幕显示蓝牙的连接情况。

屏幕显示: „ncon“ (未连接)。

请升级一下外接设备的软件。请参阅AquaLX或蓝牙加密狗数据传送软件的说明书。



屏幕显示: „con“ (连接中)。



按一下 [MODE] 键开始传送。在传送过程中屏幕显示“PrtG” (打印中) 的字样。

所有的数据按顺序逐个传送，仪器也会把测试结果存贮下来。传送完毕后，仪器返回测试状态，同时断开蓝牙连接。



在传送过程中随时可以按下On/Off键中断传送。  
仪器关机。



### ▲ ▼ 设置时间和日期 (24-小时 格式)

进入菜单 (参阅“进入菜单”)



按2次该键=屏幕箭头指向 Time 时间) 和 Date (日期)



确认



增加数值



减少数值



确认选择的设置值



在最终确认后，屏幕会显示“IS SET”字样

仪器返回到测试模式。

### 显示当前的校正数据

进入菜单 (参阅“进入菜单”)



CAL

方法

按3下该键，屏幕显示Cal字样，有箭头指向Cal

确认

在字样 CAL/„Method“之间切换显示

注意：

cAL

代表用户自定义校正

CAL

代表工厂校正



### 4 用户自定义校正



CAL

方法

按3下该键，屏幕显示Cal字样，有箭头指向Cal

确认

在字样 CAL/„Method“之间切换显示



选择一个测试方法

往24 mm比色管加入10 ml水样。

跟水样混合的水必须无色透明，(如去离子水，纯水，饮用水)。

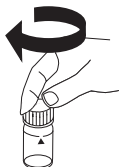

旋紧盖子

## CN 用户自定义校正



把比色管插到插槽中。  
注意插入的位置方向。



按一下该键。



方法

字样闪烁约8秒。

0.0.0

CAL

屏幕交替显示2种工作模式。



测试已知浓度的标样。

按一次该键。



方法

字样闪烁约3秒。

结果

显示测试结果，跟CAL字样交替显示。

CAL

如果显示的测试结果在允许的误差范围内，执行以下操作退出校正模式。



按一下该键。

如果显示的测试结果超过允许的范围，执行以下操作：

Mode

按1次该键增加1位数字。



按1次该键减少1位数字。

调节显示的测试结果到标准液的浓度值。

CAL

结果 + x

显示测试结果，跟CAL字样交替显示。



按住该键4秒以上再松开。

完成了用户自定义校正。自动存储校正结果。

#### 4 氟离子测试的校正模式

校正前请准备以下两种标液：

0 mg/l 和 1.0 mg/l F<sup>-</sup> 标准液以及一支干净的比色管（参阅试剂操作规程）

校正操作步骤：

进入菜单（参阅“进入菜单”）



连按3次该键，屏幕显示Cal字样，并且有箭头指向



按该键确认

CAL

按Mode键确认后，屏幕显示 CAL/F字样。

F

往干净的比色管中加入10 ml去离子水，旋紧瓶盖。

把比色管插入插槽中，确保插入的位置方向对准 X 标记。



按一下[ZERO/TEST] 键。

F

方法代码F闪烁约8秒。

0.0.0

屏幕交替显示0.0.0和CAL字样。

CAL

往去离子水中准确添加**2 ml SPADNS**试剂，旋紧瓶盖，左右摇晃，混合均匀。然后把比色管插入插槽中，确保插入的位置方向对准 X 标记。



按一下 [ZERO/TEST]键。

F

方法代码F闪烁约3秒。

F0

屏幕显示F0：

取出比色管，清空液体试剂，漂洗比色管和盖子多次，然后往比色管准确添加**10 ml标准液(1 mg/l F<sup>-</sup>)**。

往比色管中准确添加**2 ml SPADNS**试剂，旋紧瓶盖，左右摇晃，混合均匀。然后把比色管插入插槽中，确保插入的位置方向对准 X 标记。



按一下[ZERO/TEST] 键。

F

方法代码F闪烁约3秒。

## 用户自定义校正

F1



: :

屏幕显示F1。

按下 [ON/OFF] 键，仪器自动计算修正系数，并且把校正数据存储下来。

3秒后校正完成确认。



SEL

CAL

SEL

cAL



SEL

CAL



### 复位工厂校正

把用户自定义校正复位成工厂校正将会重置所有的测试方法数据以及测试量程。

如果在显示的测试结果数据上有个箭头标识，表示采用的是用户自定义的校正数据。

复位校正数据的步骤如下：

同时按住这2个键。

再轻按一次该键。

1秒后松开这2个键。

屏幕交替显示2种校正数据：

工厂校正

或：

用户自定义校正

按住Mode键将把校正数据复位到工厂校正状态。

屏幕交替显示2种状态。

关机。

## CN 检测仪器性能



请选购专门针对MD100, MD110和MD200仪器开发的标样套装来检测仪器的性能。

检测时需要选择特定的测试方法，并选择相应的标准液。常用的试剂类型有药丸，液体或粉末。对于液体试剂，请选择药丸的模式。



开机。



选择测试方法。



插入零点比色管。  
注意定位方向。

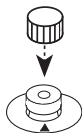

旋紧橡胶盖。



按一下 [ZERO/TEST] 键。

0.0.0

确认零点测试的结果。

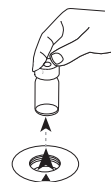

取出比色管。



往比色管中加入相应的标准液，再插入插槽中。  
注意定位方向。



按一下 [ZERO/TEST] 键。

结果

查看标准液附带的文件，看测试结果是否在允许的误差范围内。



如果超标了，请再次检查标准液是否过期了，仪器是否在工厂校正状态。如果还是不行，请把仪器返厂维修。



### MD 100, MD 110 和 MD 200 标样套装

标样套装仅可以用来检测仪器的测试准确度。禁止用它来校正仪器。在一般的工作环境下，仪器的校正数据可以稳定保存较长的时间。

标样密封保存在一支支比色管中。

标样带的证书上有明确标示出标样的浓度。在正确使用和保存标样的前提下，有效期为生产后2年。在使用前请用干净的布小心擦拭比色管外表面，确保干净无污染。

货号	材料	量程
275650	余氯标样 (药丸/液体试剂)	0,2* + 1,0* mg/l
275655	余氯标样 (药丸/液体试剂)	0,5* + 2,0* mg/l
275656	余氯标样 (药丸/液体试剂)	1,0* + 4,0* mg/l
275660	余氯标样 (药丸/粉末试剂)	0,2* + 1,0* mg/l
275670	pH标样 (药丸/液体试剂)	7,45* pH

\* 标准值，具体数值在证书上有体现。

### 用标样来检测仪器的性能



按住该键不放



轻按一下该键，再松开



松开该键

## CN 检测仪器性能

AbS

A530

屏幕快速显示以下字样：  
AbS，然后是检测的波长（比如A530代表检测530 nm）。

Mode

如果仪器有多个波长，请按Mode键滚动选择所要检测的波长。

Zero  
Test

插入零点比色管，旋紧密封盖，按下 [Zero/Test] 键。

波长

字样闪烁约3秒。

0.0.0

确认零点调节。

Zero  
Test

摇晃几次标有所需波长的比色管，插入插槽中。旋紧橡胶盖，再按下[Zero/Test]键。

波长

字样闪烁约3秒。

结果

跟证书上标示的数值比较。



如果标液没过期，检测结果超过许可的范围，请把仪器返厂维修。  
到时工厂会仔细检测仪器的性能。

### 验证标准套装

MD 100 / MD 110 / MD 200 验证标准套装可以用来检测仪器在不同波长下的测试准确度和再现性。

套装包括1支零点比色管和6支检测不同波长的比色管。可以用来检测MD 100 / MD 110 / MD 200 所有的型号。

在正确使用和保存的前提下，有效期为生产后2年。测试的结果单位为吸光度的单位mAbs。

货号	材料
21 56 70	MD 100 / MD 110 / MD 200验证标准套装

**MD 100, MD 110, MD 200技术参数**

仪器	自动选择波长 直读式比色仪
光源	LEDs发光二极管，干涉滤光片IF 透明比色池 每台仪器最多3个波长 波长参数 430 nm $\Delta\lambda = 5$ nm 530 nm $\Delta\lambda = 5$ nm 560 nm $\Delta\lambda = 5$ nm 580 nm $\Delta\lambda = 5$ nm 610 nm $\Delta\lambda = 6$ nm 660 nm $\Delta\lambda = 5$ nm
光度范围	-2600 - 2600 mAbs
波长准确度	$\pm 1$ nm
光度准确度 *	3 % FS ( 20 °C – 25 °C)
光度分辨率	0,01 A
Auto-OFF	自动关机 最后一次按键10-25分钟后自动关机 (不同的测试方法有不同的响应时间)
显示屏	背光液晶显示屏 LCD
时间	实时时钟
校正	用户自定义和工厂校正两种 可复位到工厂校正
周边环境	温度: 5– 40 °C 相对湿度: 30–90 % (非冷凝)
防水	可漂浮 IP 68 (0.1米水下1小时)
CE	CE证书 可以在官网 <a href="http://www.lovibond.com">www.lovibond.com</a> 下载证书

\*测试标准溶液



请使用原厂试剂，以保证测试准确度。

### **MD 100技术参数**

电池	4 节7号电池 (AAA/LR 03)
工作时间	在关闭背光功能的情况下可连续使用17个小时，或执行5000次测试。
存储	可贮存16组的数据
串口	红外数据传送接口
尺寸	155 x 75 x 35 mm (长x宽x高)
重量	约260 克 ( 包括电池 )

### **MD 110技术参数**

电池	4 节7号电池 (AAA/LR 03)
工作时间	在关闭背光和蓝牙的情况下，可连续使用17个小时，或执行5000次测试。
存储	可存贮125组的数据
串口	Bluetooth® 4.0 蓝牙4.0标准，可发送存贮的数据
Bluetooth® 蓝牙	规格: Modul: BLE113-A Bluetooth® 4.0 LE FCC ID: QOQBT113 IC: 5123A-BGTBLE113
尺寸	155 x 75 x 35 mm (长x宽x高)
重量	约260 克(包括电池)

### **MD 200技术参数**

电池	4 节5号电池 (Mignon AA/LR 6)
工作时间 测	在关闭背光的情况下可连续使用53个小时或执行15000次测试。
存储	可存贮16组数据
串口	红外数据传送接口
尺寸	190 x 110 x 55 mm (长x宽x高)
重量	约455 克 (包括电池)

### 操作信息

**Hi**

测试超量程，或浊度太高。

**Lo**

测试值低于量程下限。



请更换电池，无法测试。

**btLo**

电池电量低，可以测试，但没有背光。



显示测试结果的界面上有箭头符号，表示采用的是用户自定义的校正方法。（参阅“复位工厂校正”）。

### 故障代码

**E27 / E28 / E29**

光被吸收得太多了，可能原因：镜片脏了。

**E 10 / E 11**

校正系数“超范围”了。

**E 20 / E 21**

检测器检测到太多光了。

**E23 / E24 / E25**

检测器检测到太多光了。

**E 22**

在测试时检测到电池电量低，请更换电池。

**E 70**

校正数据不全或有误，请联系厂家 [techsupport@tintometer.de](mailto:techsupport@tintometer.de)。

**E 71**

**E 72**

**⋮**





**Tintometer GmbH**

Lovibond® Water Testing  
Schleefstraße 8-12  
44287 Dortmund  
Tel.: +49 (0)231/94510-0  
Fax: +49 (0)231/94510-30  
sales@lovibond.com  
www.lovibond.com  
Germany

**The Tintometer Limited**

Lovibond House  
Sun Rise Way  
Amesbury, SP4 7GR  
Tel.: +44 (0)1980 664800  
Fax: +44 (0)1980 625412  
water.sales@lovibond.uk  
www.lovibond.com  
UK

**Tintometer Inc.**

6456 Parkland Drive  
Sarasota, FL 34243  
Tel: 941.756.6410  
Fax: 941.727.9654  
sales@lovibond.us  
www.lovibond.us  
USA

**Tintometer Spain**

Postbox: 24047  
08080 Barcelona  
Tel.: +34 661 606 770  
sales@tintometer.es  
www.lovibond.com  
Spain

**Tintometer China**

Room 1001, China Life Tower  
16 Chaoyangmenwai Avenue,  
Beijing, 100020  
Tel.: +86 10 85251111 App. 330  
Fax: +86 10 85251001  
chinaoffice@tintometer.com  
www.lovibond.com/zh  
China

**Tintometer South East Asia**

Unit B-3-12, BBT One Boulevard,  
Lebu Nilam 2, Bandar Bukit Tinggi,  
Klang, 41200, Selangor D.E  
Tel.: +60 (0)3 3325 2285/6  
Fax: +60 (0)3 3325 2287  
lovibond.asia@lovibond.com  
www.lovibond.com  
Malaysia

**Tintometer Brazil**

Caixa Postal: 271  
CEP: 13201-970  
Jundiaí – SP  
Tel.: +55 (11) 3230-6410  
sales@lovibond.us  
www.lovibond.com.br  
Brazil

**Tintometer Indien Pvt. Ltd.**

Door No: 7-2-C-14, 2<sup>nd</sup>, 3<sup>rd</sup> & 4<sup>th</sup> Floor  
Sanathnagar Industrial Estate,  
Hyderabad: 500018, Telangana  
Tel: +91 (0) 40 23883300  
Toll Free: 1 800 599 3891/ 3892  
indiaoffice@lovibond.in  
www.lovibondwater.in  
India

Technische Änderungen vorbehalten  
Printed in Germany 12/20  
No.: 00 38 63 88

Lovibond® und Tintometer®  
sind eingetragene Warenzeichen  
der Tintometer Firmengruppe







Cloro T

M100

0.01 - 6.0 mg/L Cl<sub>2</sub><sup>a)</sup>

CL6

DPD

## Informazioni specifiche dello strumento

Il test può essere eseguito sui seguenti dispositivi. Inoltre, sono indicate la cuvetta richiesta e il range di assorbimento del fotometro.

Dispositivi	Cuvetta	λ	Campo di misura
MD 100, MD 110, MD 200, MD 600, MD 610, MD 640, MultiDirect, PM 600, PM 620, PM 630	ø 24 mm	530 nm	0.01 - 6.0 mg/L Cl <sub>2</sub> <sup>a)</sup>
Scuba II	ø 24 mm	530 nm	0.1 - 6.0 mg/L Cl <sub>2</sub> <sup>a)</sup>
XD 7000, XD 7500	ø 24 mm	510 nm	0.01 - 6.0 mg/L Cl <sub>2</sub> <sup>a)</sup>

## Materiale

Materiale richiesto (in parte facoltativo):

Reagenti	Unità di imballaggio	N. ordine
Confezione di ricarica Suba II	1 pz.	525600
DPD No. 1	Pastiglia / 100	511050BT
DPD No. 1	Pastiglia / 250	511051BT
DPD No. 1	Pastiglia / 500	511052BT
DPD No. 3	Pastiglia / 100	511080BT
DPD No. 3	Pastiglia / 250	511081BT
DPD No. 3	Pastiglia / 500	511082BT
DPD No. 1 Alto Calcio <sup>e)</sup>	Pastiglia / 100	515740BT
DPD No. 1 Alto Calcio <sup>e)</sup>	Pastiglia / 250	515741BT
DPD No. 1 Alto Calcio <sup>e)</sup>	Pastiglia / 500	515742BT
DPD No. 3 High Calcium <sup>e)</sup>	Pastiglia / 100	515730BT
DPD No. 3 High Calcium <sup>e)</sup>	Pastiglia / 250	515731BT
DPD No. 3 High Calcium <sup>e)</sup>	Pastiglia / 500	515732BT
DPD No. 4	Pastiglia / 100	511220BT
DPD No. 4	Pastiglia / 250	511221BT
DPD No. 4	Pastiglia / 500	511222BT

## Standards disponibles

Titolo	Unità di imballaggio	N. ordine
ValidCheck Cloro 1,5 mg/l	1 pz.	48105510

## Campo di applicazione

- Trattamento acqua di scarico
- Controllo disinfettante
- Acqua di caldaia
- Acqua di raffreddamento
- Trattamento acqua non depurata
- Controllo acqua in vasca
- Trattamento acqua di piscina
- Trattamento acqua potabile

## Prelievo del campione

1. Nella preparazione del campione occorre evitare la degassificazione del cloro, ad es. utilizzando pipette e agitando.
2. L'analisi deve essere eseguita subito dopo il prelievo del campione.

## Preparazione

1. Pulizia delle cuvette:  
Poiché molti detersivi ad uso domestico (ad es. detersivo per piatti) contengono sostanze riducenti, nella rilevazione del cloro si potrebbero ottenere risultati troppo bassi. Per escludere tali errori di misura è necessario che i dispositivi in vetro siano esenti dal consumo di cloro. I dispositivi in vetro inoltre vengono conservati in una soluzione di ipoclorito di sodio (0,1 g/L) per un'ora e successivamente vengono risciacquati abbondantemente con acqua demineralizzata.
2. Per la singola rilevazione del cloro libero e del cloro totale è opportuno utilizzare un apposito kit di cuvette per ciascuna procedura (vedere EN ISO 7393-2, par. 5.3).
3. Lo sviluppo della colorazione del DPD avviene con un valore di pH compreso tra 6,2 e 6,5. I reagenti contengono pertanto un tampone per la regolazione del valore di pH. Le acque fortemente alcaline o acide tuttavia devono essere portate prima dell'analisi entro un range di pH compreso tra 6 e 7 (con 0,5 mol/l di acido solforico o 1 mol/l di liscivia).



## Esecuzione della rilevazione Cloro, libero con compressa

Selezionare il metodo nel dispositivo.

Selezionare inoltre la determinazione: libero

Per questo metodo, non è necessario eseguire una misurazione ZERO ogni volta sui seguenti dispositivi: XD 7000, XD 7500



Riempire una cuvetta da 24 mm con **10 ml di campione**.

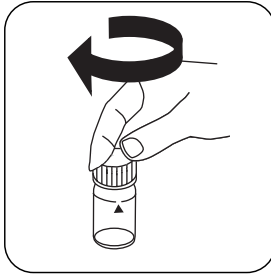

Chiudere la/e cuvetta/e.

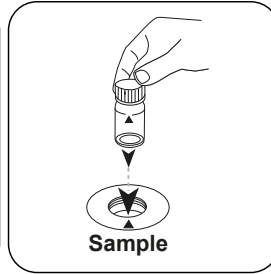

Posizionare la **cuvetta del campione** nel vano di misurazione. Fare attenzione al posizionamento.

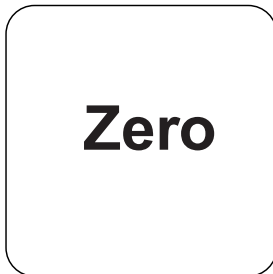

Premere il tasto **ZERO**.

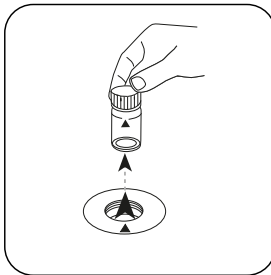

Prelevare la cuvetta dal vano di misurazione.



Svuotare la cuvetta finché non rimangono alcune gocce.

In caso di dispositivi che **non richiedono una misurazione ZERO, iniziare da qui.**

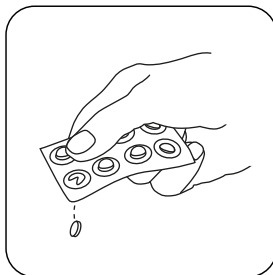

Aggiungere **una pastiglia DPD No. 1**.

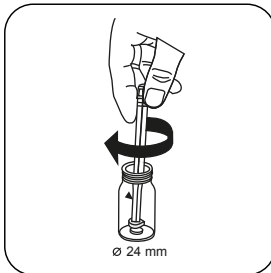

Frantumare la/e pastiglia/e con una leggera rotazione.



Immettere il **campione** nella cuvetta fino a raggiungere la **tacca dei 10 ml**.

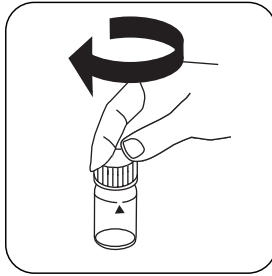

Chiudere la/e cuvetta/e.

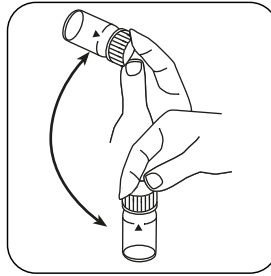

Far sciogliere la/e pastiglia/e agitando.

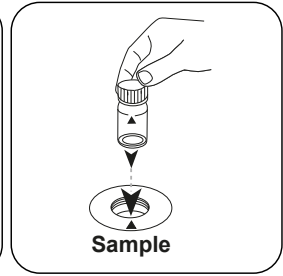

Posizionare la **cuvetta del campione** nel vano di misurazione. Fare attenzione al posizionamento.

# Test

Premere il tasto **TEST** (XD: **START**).

Sul display compare il risultato in mg/l di Cloro libero.



## Esecuzione della rilevazione Cloro, totale con compressa

Selezionare il metodo nel dispositivo.

Selezionare inoltre la determinazione: totale

Per questo metodo, non è necessario eseguire una misurazione ZERO ogni volta sui seguenti dispositivi: XD 7000, XD 7500



Riempire una cuvetta da 24 mm con **10 ml di campione**.

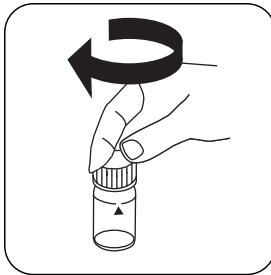

Chiudere la/e cuvetta/e.

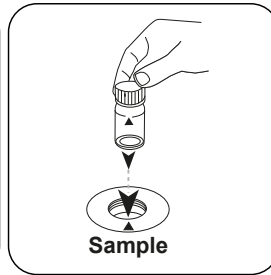

Posizionare la **cuvetta del campione** nel vano di misurazione. Fare attenzione al posizionamento.

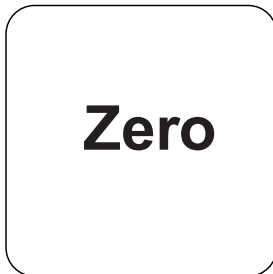

Premere il tasto **ZERO**.

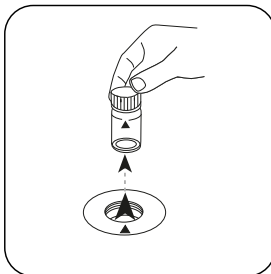

Prelevare la cuvetta dal vano di misurazione.

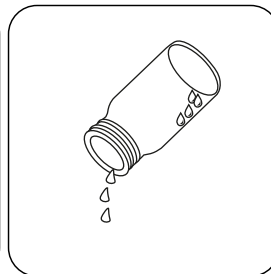

Svuotare la cuvetta finché non rimangono alcune gocce.

In caso di dispositivi che **non richiedono una misurazione ZERO, iniziare da qui.**

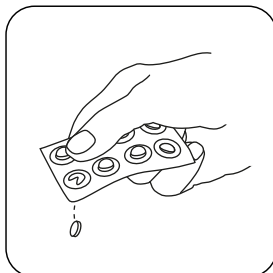

Aggiungere una pastiglia **DPD No. 1**.

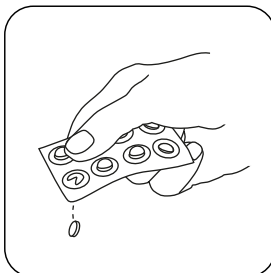

Aggiungere una pastiglia **DPD No. 3**.

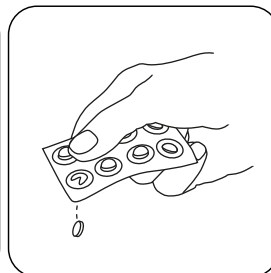

In alternativa al **DPD No. 1 e No. 3 tablet**, un **DPD No. 4 tablet** può essere aggiunto.

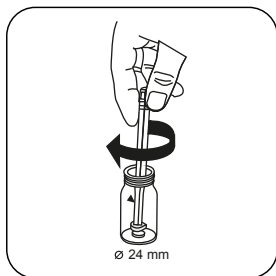

Frantumare la/e pastiglia/e con una leggera rotazione.



Immettere il **campione** nella cuvetta fino a raggiungere la **tacca dei 10 ml**.

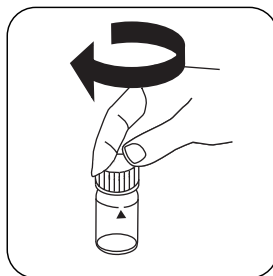

Chiudere la/e cuvetta/e.

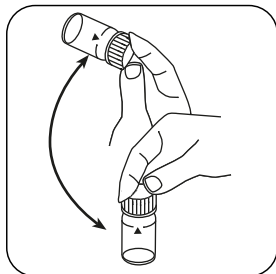

Far sciogliere la/e pastiglia/e agitando.

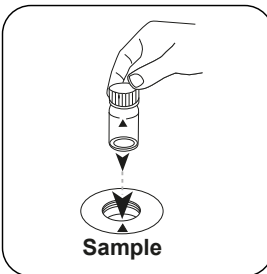

Posizionare la **cuvetta del campione** nel vano di misurazione. Fare attenzione al posizionamento.

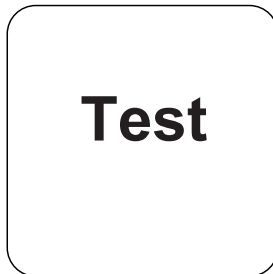

Premere il tasto **TEST** (XD: **START**).

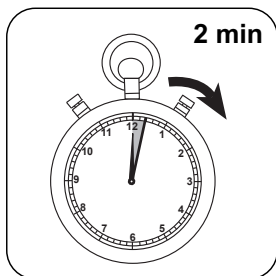

Attendere un **tempo di reazione di 2 minuti/i**.

Allo scadere del tempo di reazione viene effettuata automaticamente la misurazione. Sul display compare il risultato in mg/l di Cloro totale.



## Esecuzione della rilevazione Cloro, determinazione differenziata con compressa

Selezionare il metodo nel dispositivo.

Selezionare inoltre la determinazione: differenziato

Per questo metodo, non è necessario eseguire una misurazione ZERO ogni volta sui seguenti dispositivi: XD 7000, XD 7500



Riempire una cuvetta da 24 mm con **10 ml di campione**.

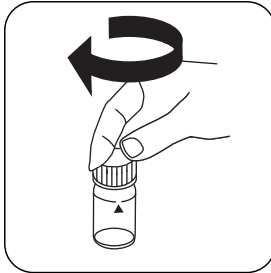

Chiudere la/e cuvetta/e.

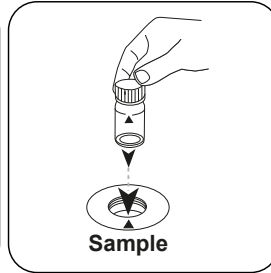

Posizionare la **cuvetta del campione** nel vano di misurazione. Fare attenzione al posizionamento.

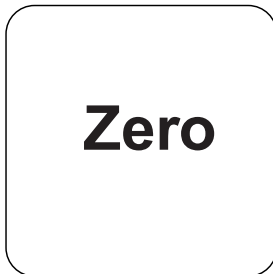

Premere il tasto **ZERO**.

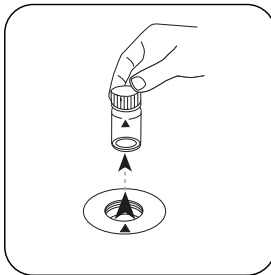

Prelevare la cuvetta dal vano di misurazione.

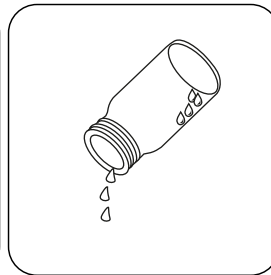

Svuotare la cuvetta finché non rimangono alcune gocce.

In caso di dispositivi che **non richiedono una misurazione ZERO, iniziare da qui.**

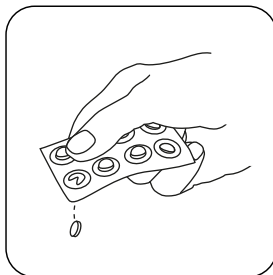

Aggiungere **una pastiglia DPD No. 1**.

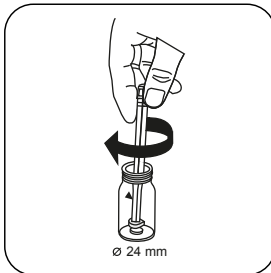

Frantumare la/e pastiglia/e con una leggera rotazione.



Immettere il **campione** nella cuvetta fino a raggiungere la **tacca dei 10 ml**.

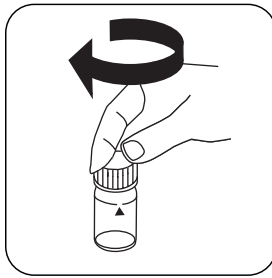

Chiudere la/e cuvetta/e.

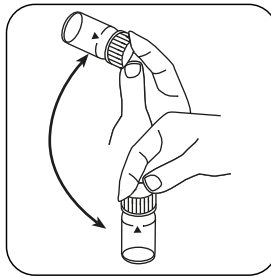

Far sciogliere la/e pastiglia/e agitando.

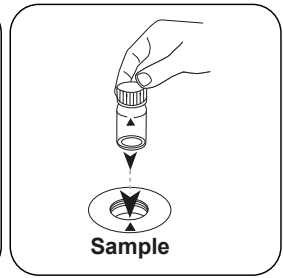

Posizionare la **cuvetta del campione** nel vano di misurazione. Fare attenzione al posizionamento.

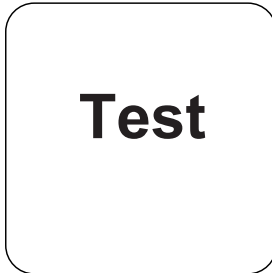

Premere il tasto **TEST** (XD: **START**).

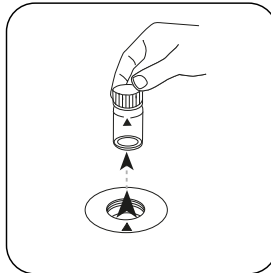

Prelevare la cuvetta dal vano di misurazione.

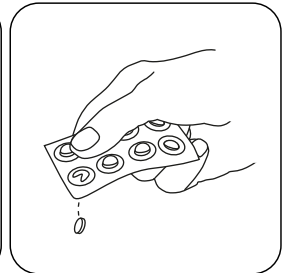

Aggiungere **una pastiglia DPD No. 3**.

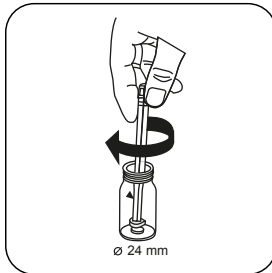

Frantumare la/e pastiglia/e con una leggera rotazione.

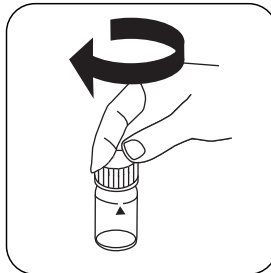

Chiudere la/e cuvetta/e.

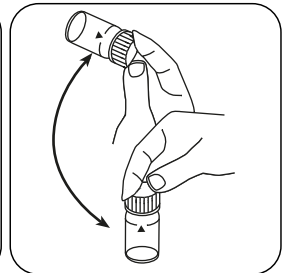

Far sciogliere la/e pastiglia/e agitando.



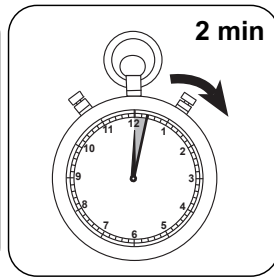
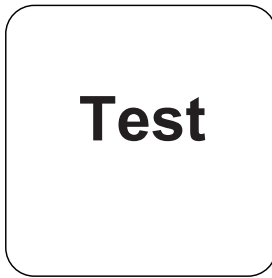
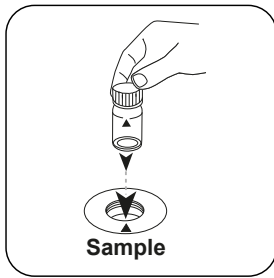

Posizionare la **cuvetta del campione** nel vano di misurazione. Fare attenzione al posizionamento.

Premere il tasto **TEST** (XD: **START**).

Attendere un **tempo di reazione di 2 minuto/i** .

Allo scadere del tempo di reazione viene effettuata automaticamente la misurazione. Sul display compare il risultato in mg/l di cloro libero, mg/l cloro combinato, mg/l cloro totale.

## Metodo chimico

DPD

## Appendice

### Funzione di calibrazione per fotometri di terze parti

Conc. = a + b•Abs + c•Abs<sup>2</sup> + d•Abs<sup>3</sup> + e•Abs<sup>4</sup> + f•Abs<sup>5</sup>

	ø 24 mm	□ 10 mm
a	-5.41232 • 10 <sup>-2</sup>	-5.41232 • 10 <sup>-2</sup>
b	1.78498 • 10 <sup>+0</sup>	3.83771 • 10 <sup>+0</sup>
c	-8.7417 • 10 <sup>-2</sup>	-4.04085 • 10 <sup>-1</sup>
d	1.08323 • 10 <sup>-1</sup>	1.07655 • 10 <sup>+0</sup>
e		
f		

## Interferenze

### Interferenze permanenti

- Tutti gli ossidanti presenti nei campioni reagiscono come il cloro dando risultati troppo elevati.

### Interferenze escludibili

- Le interferenze da parte di rame e ferro(III) devono essere eliminate con EDTA.
- In caso di campioni con un elevato tenore di calcio\* e/o un'elevata conducibilità\*, utilizzando le pastiglie di reagenti potrebbe verificarsi un intorbidimento del campione con conseguenti errori di misurazione. In questo caso si possono utilizzare in alternativa la pastiglia di reagente DPD No. 1 High Calcium e la pastiglia di reagente DPD No. 3 High Calcium.  
\*Non è possibile indicare i valori esatti in quanto l'intorbidimento dipende dal tipo e dalla composizione dell'acqua campione.
- Se si utilizzano pastiglie, le concentrazioni di cloro maggiori di 10 mg/L possono dare risultati entro il range di misura fino a 0 mg/L. Se la concentrazione di cloro è troppo elevata, il campione deve essere diluito con acqua priva di cloro. 10 ml del campione diluito vengono addizionati con il reagente e la misurazione viene ripetuta (test di plausibilità).

Interferenze	da / [mg/L]
CrO <sub>4</sub> <sup>2-</sup>	0.01
MnO <sub>2</sub>	0.01



## Validazione metodo

<b>Limite di rilevabilità</b>	0.02 mg/L
<b>Limite di quantificazione</b>	0.06 mg/L
<b>Estremità campo di misura</b>	6 mg/L
<b>Sensibilità</b>	2.05 mg/L / Abs
<b>Intervallo di confidenza</b>	0.04 mg/L
<b>Deviazione standard della procedura</b>	0.019 mg/L
<b>Coefficiente di variazione della procedura</b>	0.87 %

## Conforme

EN ISO 7393-2

<sup>a</sup>Determinazione di libero, vincolato, totale possibile | <sup>a</sup>Reagente ausiliario, in alternativa a DPD n. 1 / no 3 in caso di torbidità del campione a causa di alto contenuto di ioni di calcio e / o alta conduttività



Cloro HR T

M103

0.1 - 10 mg/L Cl<sub>2</sub><sup>a)</sup>

CL10

DPD

## Informazioni specifiche dello strumento

Il test può essere eseguito sui seguenti dispositivi. Inoltre, sono indicate la cuvetta richiesta e il range di assorbimento del fotometro.

Dispositivi	Cuvetta	$\lambda$	Campo di misura
MD 100, MD 110, MD 200, MD 600, MD 610, MD 640, MultiDirect, PM 600, PM 620, PM 630	ø 24 mm	530 nm	0.1 - 10 mg/L Cl <sub>2</sub> <sup>a)</sup>

## Materiale

Materiale richiesto (in parte facoltativo):

Reagenti	Unità di imbal- laggio	N. ordine
DPD No. 1 HR	Pastiglia / 100	511500BT
DPD No. 1 HR	Pastiglia / 250	511501BT
DPD No. 1 HR	Pastiglia / 500	511502BT
DPD No. 3 HR	Pastiglia / 100	511590BT
DPD No. 3 HR	Pastiglia / 250	511591BT
DPD No. 3 HR	Pastiglia / 500	511592BT
Set DPD No. 1 HR/No. 3 HR <sup>#</sup>	ciascuna 100	517791BT
Set DPD No. 1 HR/No. 3 HR <sup>#</sup>	ciascuna 250	517792BT
DPD No. 1 Alto Calcio <sup>e)</sup>	Pastiglia / 100	515740BT
DPD No. 1 Alto Calcio <sup>e)</sup>	Pastiglia / 250	515741BT
DPD No. 1 Alto Calcio <sup>e)</sup>	Pastiglia / 500	515742BT
DPD No. 3 High Calcium <sup>e)</sup>	Pastiglia / 100	515730BT
DPD No. 3 High Calcium <sup>e)</sup>	Pastiglia / 250	515731BT
DPD No. 3 High Calcium <sup>e)</sup>	Pastiglia / 500	515732BT

## Campo di applicazione

- Trattamento acqua di scarico
- Controllo disinfettante
- Acqua di caldaia
- Acqua di raffreddamento
- Trattamento acqua non depurata
- Controllo acqua in vasca
- Trattamento acqua di piscina

## Prelievo del campione

1. Nella preparazione del campione occorre evitare la degassificazione del cloro, ad es. utilizzando pipette e agitando.
2. L'analisi deve essere eseguita subito dopo il prelievo del campione.

## Preparazione

1. Pulizia delle cuvette:  
Poiché molti detersivi ad uso domestico (ad es. detersivo per piatti) contengono sostanze riducenti, nella rilevazione del cloro si potrebbero ottenere risultati troppo bassi. Per escludere tali errori di misura è necessario che i dispositivi in vetro siano esenti dal consumo di cloro. I dispositivi in vetro inoltre vengono conservati in una soluzione di ipoclorito di sodio (0,1 g/L) per un'ora e successivamente vengono risciacquati abbondantemente con acqua demineralizzata.
2. Per la singola rilevazione del cloro libero e del cloro totale è opportuno utilizzare un apposito kit di cuvette per ciascuna procedura (vedere EN ISO 7393-2, par. 5.3).
3. Lo sviluppo della colorazione del DPD avviene con un valore di pH compreso tra 6,2 e 6,5. I reagenti contengono pertanto un tampone per la regolazione del valore di pH. Le acque fortemente alcaline o acide tuttavia devono essere portate prima dell'analisi entro un range di pH compreso tra 6 e 7 (con 0,5 mol/l di acido solforico o 1 mol/l di liscivia).

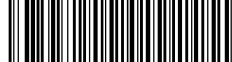

## Esecuzione della rilevazione Cloro HR, libero con compressa

Selezionare il metodo nel dispositivo.

Selezionare inoltre la determinazione: libero

Per questo metodo, non è necessario eseguire una misurazione ZERO ogni volta sui seguenti dispositivi: XD 7000, XD 7500



Riempire una cuvetta da 24 mm con **10 ml di campione**.

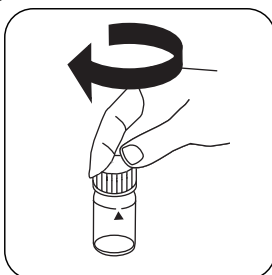

Chiudere la/e cuvetta/e.

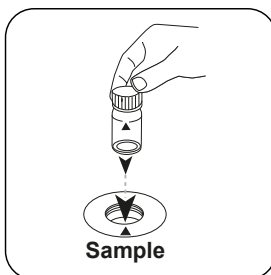

Posizionare la **cuvetta del campione** nel vano di misurazione. Fare attenzione al posizionamento.

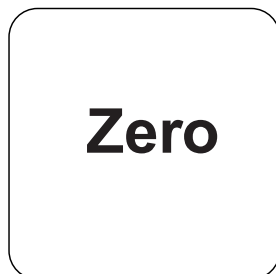

Premere il tasto **ZERO**.

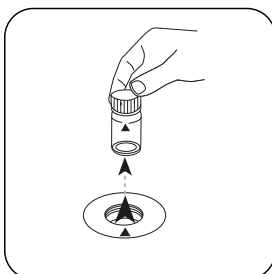

Prelevare la cuvetta dal vano di misurazione.

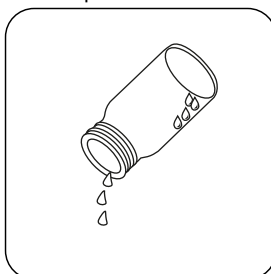

Svuotare la cuvetta finché non rimangono alcune gocce.

In caso di dispositivi che **non richiedono una misurazione ZERO, iniziare da qui.**

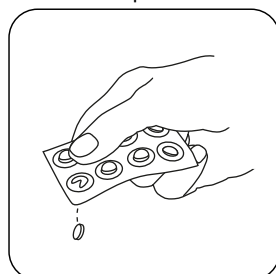

Aggiungere **una pastiglia DPD No. 1 HR**.

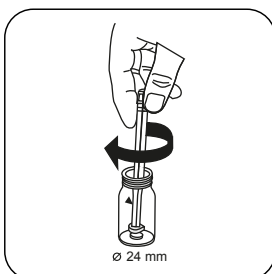

Frantumare la/e pastiglia/e con una leggera rotazione.



Immettere il **campione** nella cuvetta fino a raggiungere la **tacca dei 10 ml**.

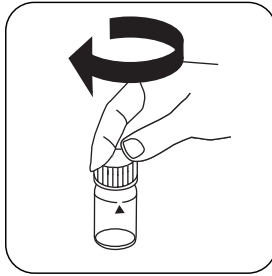

Chiudere la/e cuvetta/e.

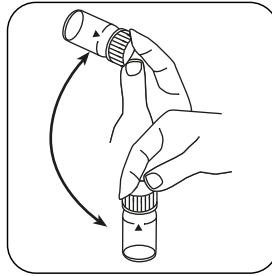

Far sciogliere la/e pastiglia/e agitando.

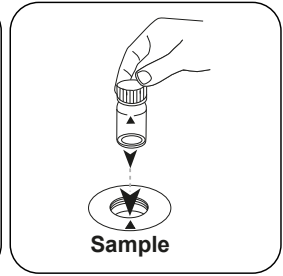

Posizionare la **cuvetta del campione** nel vano di misurazione. Fare attenzione al posizionamento.

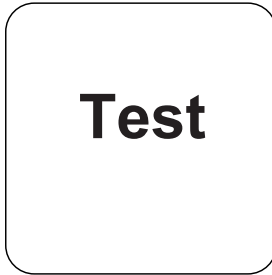

Premere il tasto **TEST** (XD: **START**).

Sul display compare il risultato in mg/l di Cloro libero.

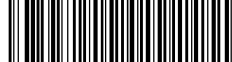

## Esecuzione della rilevazione Cloro HR, totale con compressa

Selezionare il metodo nel dispositivo.

Selezionare inoltre la determinazione: totale

Per questo metodo, non è necessario eseguire una misurazione ZERO ogni volta sui seguenti dispositivi: XD 7000, XD 7500



Riempire una cuvetta da 24 mm con **10 ml di campione**.

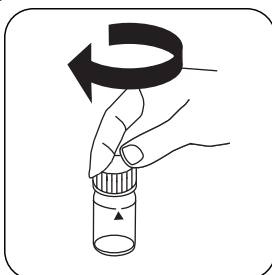

Chiudere la/e cuvetta/e.

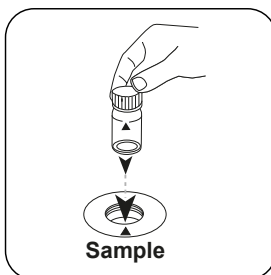

Posizionare la **cuvetta del campione** nel vano di misurazione. Fare attenzione al posizionamento.

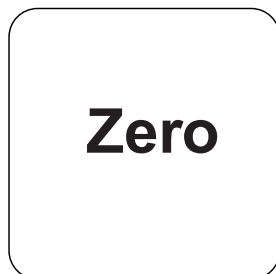

Premere il tasto **ZERO**.

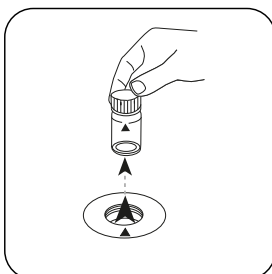

Prelevare la cuvetta dal vano di misurazione.

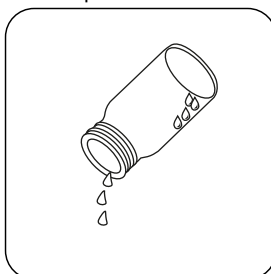

Svuotare la cuvetta finché non rimangono alcune gocce.

In caso di dispositivi che **non richiedono una misurazione ZERO, iniziare da qui.**

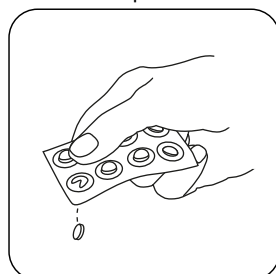

Aggiungere una **pastiglia DPD No. 1 HR**.

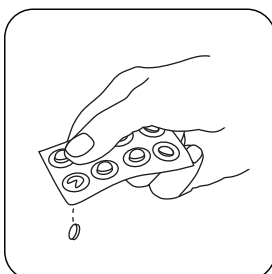

Aggiungere una **pastiglia DPD No. 3 HR**.

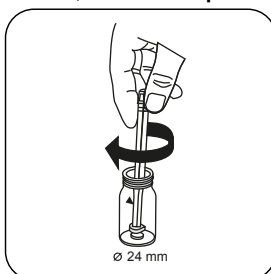

Frantumare la/e pastiglia/e con una leggera rotazione.





Immettere il **campione** nella cuvetta fino a raggiungere la **tacca dei 10 ml**.

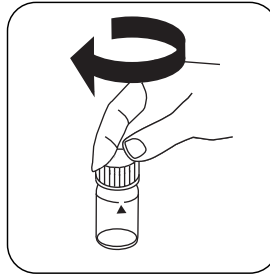

Chiudere la/e cuvetta/e.

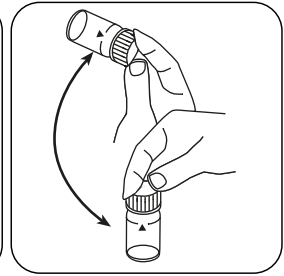

Far sciogliere la/e pastiglia/e agitando.

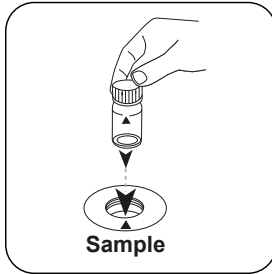

Posizionare la **cuvetta del campione** nel vano di misurazione. Fare attenzione al posizionamento.

Allo scadere del tempo di reazione viene effettuata automaticamente la misurazione. Sul display compare il risultato in mg/l di Cloro totale.

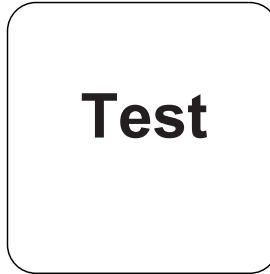

Premere il tasto **TEST** (XD: **START**).

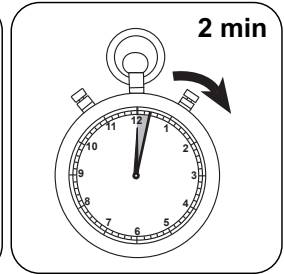

Attendere un **tempo di reazione di 2 minuti**.



## Esecuzione della rilevazione Cloro HR, determinazione differenziata con compressa

Selezionare il metodo nel dispositivo.

Selezionare inoltre la determinazione: differenziato

Per questo metodo, non è necessario eseguire una misurazione ZERO ogni volta sui seguenti dispositivi: XD 7000, XD 7500



Riempire una cuvetta da 24 mm con **10 ml di campione**.

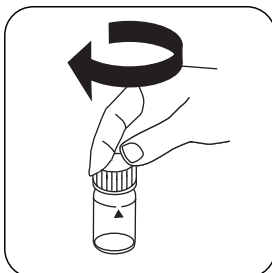

Chiudere la/e cuvetta/e.

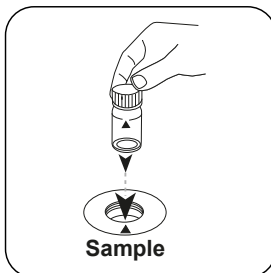

Posizionare la **cuvetta del campione** nel vano di misurazione. Fare attenzione al posizionamento.

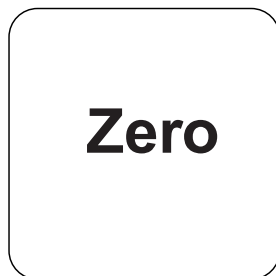

Premere il tasto **ZERO**.

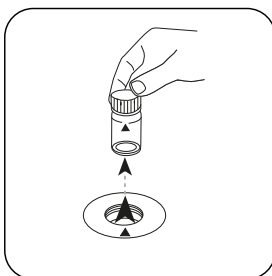

Prelevare la cuvetta dal vano di misurazione.

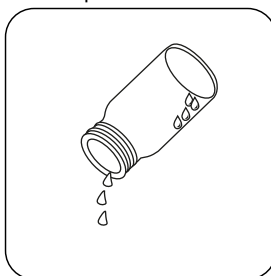

Svuotare la cuvetta finché non rimangono alcune gocce.

In caso di dispositivi che **non richiedono una misurazione ZERO, iniziare da qui.**

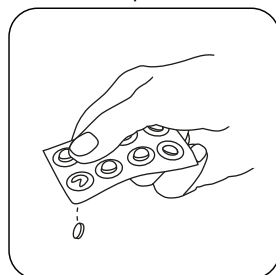

Aggiungere **una pastiglia DPD No. 1 HR**.

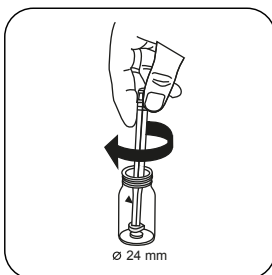

Frantumare la/e pastiglia/e con una leggera rotazione.



Immettere il **campione** nella cuvetta fino a raggiungere la **tacca dei 10 ml**.

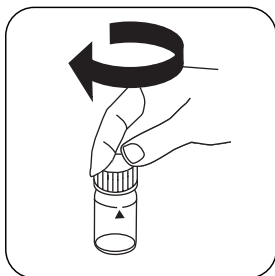

Chiudere la/e cuvetta/e.

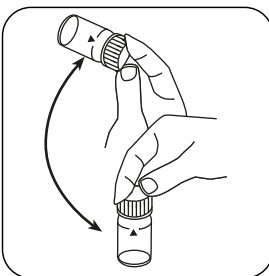

Far sciogliere la/e pastiglia/e agitando.

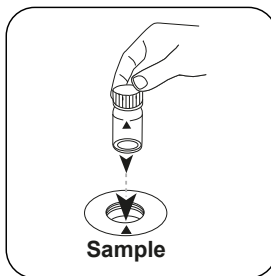

Posizionare la **cuvetta del campione** nel vano di misurazione. Fare attenzione al posizionamento.

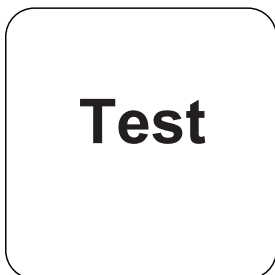

Premere il tasto **TEST (XD: START)**.

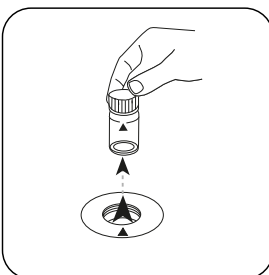

Prelevare la cuvetta dal vano di misurazione.

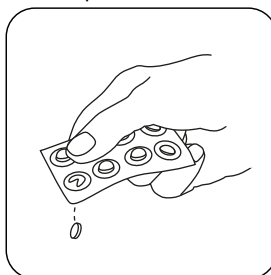

Aggiungere **una pastiglia DPD No. 3 HR**.

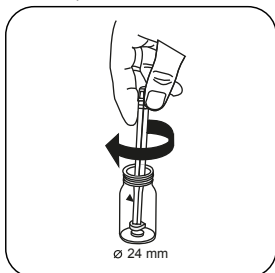

Frantumare la/e pastiglia/e con una leggera rotazione.

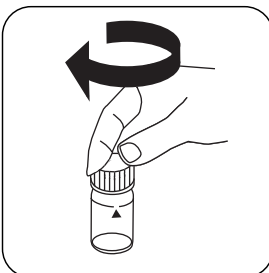

Chiudere la/e cuvetta/e.

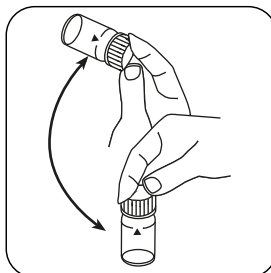

Far sciogliere la/e pastiglia/e agitando.

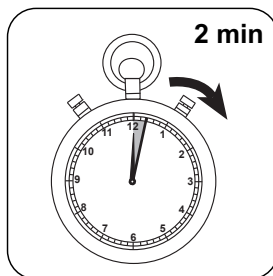
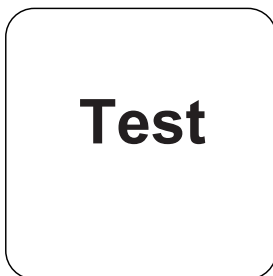
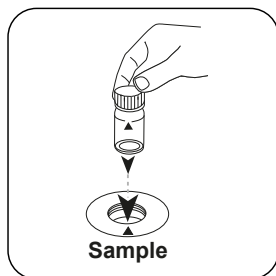

Posizionare la **cuvetta del campione** nel vano di misurazione. Fare attenzione al posizionamento.

Premere il tasto **TEST** (XD: **START**).

Attendere un **tempo di reazione di 2 minuto/i** .

Allo scadere del tempo di reazione viene effettuata automaticamente la misurazione. Sul display compare il risultato in mg/l di cloro libero, mg/l cloro combinato, mg/l cloro totale.

## Metodo chimico

DPD

## Appendice

### Funzione di calibrazione per fotometri di terze parti

Conc. = a + b•Abs + c•Abs<sup>2</sup> + d•Abs<sup>3</sup> + e•Abs<sup>4</sup> + f•Abs<sup>5</sup>

	ø 24 mm	□ 10 mm
a	4.46524 • 10 <sup>-2</sup>	4.46524 • 10 <sup>-2</sup>
b	1.50355 • 10 <sup>+0</sup>	3.23263 • 10 <sup>+0</sup>
c	9.34178 • 10 <sup>-2</sup>	4.31824 • 10 <sup>-1</sup>
d		
e		
f		

## Interferenze

### Interferenze permanenti

- Tutti gli ossidanti presenti nei campioni reagiscono come il cloro dando risultati troppo elevati.

### Interferenze escludibili

- Le interferenze da parte di rame e ferro(III) devono essere eliminate con EDTA.
- In caso di campioni con un elevato tenore di calcio\* e/o un'elevata conducibilità\*, utilizzando le pastiglie di reagente potrebbe verificarsi un intorbidimento del campione con conseguenti errori di misurazione. In questo caso si possono utilizzare in alternativa la pastiglia di reagente DPD No. 1 High Calcium e la pastiglia di reagente DPD No. 3 High Calcium.

\*Non è possibile indicare i valori esatti in quanto l'intorbidimento dipende dal tipo e dalla composizione dell'acqua campione.

### Conforme

EN ISO 7393-2

<sup>a</sup>Determinazione di libero, vincolato, totale possibile | <sup>e</sup>Reagente ausiliario, in alternativa a DPD n. 1 / no 3 in caso di torbidità del campione a causa di alto contenuto di ioni di calcio e / o alta conducibilità | <sup>h</sup>Bacchetta compresa



CYA T

M160

10 - 160 mg/L CyA

CyA

Melamina

## Informazioni specifiche dello strumento

Il test può essere eseguito sui seguenti dispositivi. Inoltre, sono indicate la cuvetta richiesta e il range di assorbimento del fotometro.

Dispositivi	Cuvetta	$\lambda$	Campo di misura
MD 100, MD 110, MD 200, MD 600, MD 610, MD 640, MultiDirect, PM 600, PM 620, PM 630, XD 7000, XD 7500	ø 24 mm	530 nm	10 - 160 mg/L CyA

## Materiale

Materiale richiesto (in parte facoltativo):

Reagenti	Unità di imbal- laggio	N. ordine
Test CyA	Pastiglia / 100	511370BT
Test CyA	Pastiglia / 250	511371BT
Acqua demineralizzata	100 mL	461275
Acqua demineralizzata	250 mL	457022

## Campo di applicazione

- Controllo acqua in vasca

## Note

1. L'acido cianurico provoca un intorbidimento distribuito molto finemente dall'aspetto lattiginoso. Single particelle non sono imputabili alla presenza di acido cianurico.





## Esecuzione della rilevazione Test acido cianurico con pastiglia

Selezionare il metodo nel dispositivo.

Per questo metodo, non è necessario eseguire una misurazione ZERO ogni volta sui seguenti dispositivi: XD 7000, XD 7500

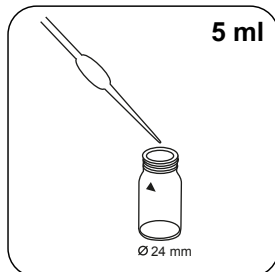

Riempire una cuvetta da 24 mm con **5 ml di acqua demineralizzata**.

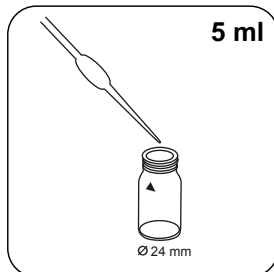

Immettere **5 ml di campione** nella cuvetta.

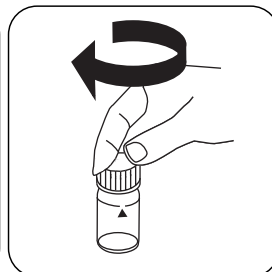

Chiudere la/e cuvetta/e.

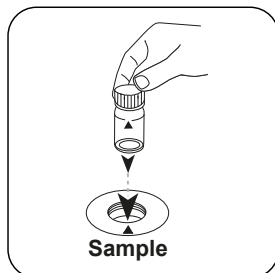

Posizionare la **cuvetta del campione** nel vano di misurazione. Fare attenzione al posizionamento.

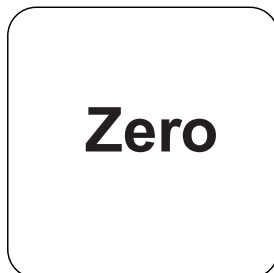

Premere il tasto **ZERO**.

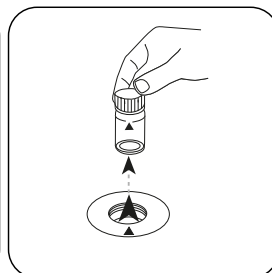

Prelevare la cuvetta dal vano di misurazione.

In caso di dispositivi che **non richiedono una misurazione ZERO, iniziare da qui.**

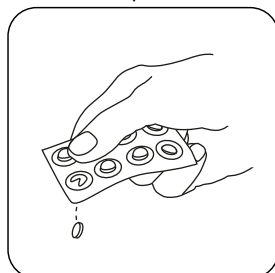

Aggiungere **una pastiglia CyA-Test**.

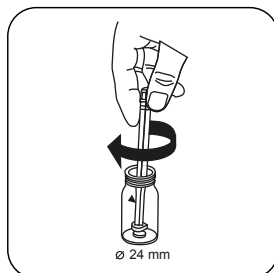

Frantumare la/e pastiglia/e con una leggera rotazione.

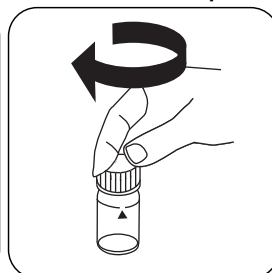

Chiudere la/e cuvetta/e.



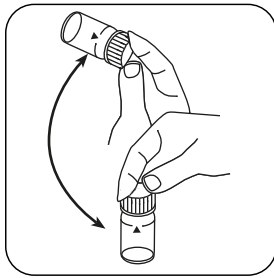

Far sciogliere la/e pastiglia/e agitando.

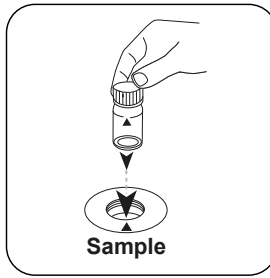

Posizionare la **cuvetta del campione** nel vano di misurazione. Fare attenzione al posizionamento.

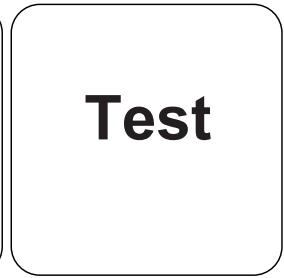

Premere il tasto **TEST** (XD: **START**).

Sul display compare il risultato in mg/l di acido cianurico .



## Metodo chimico

Melammina

### Funzione di calibrazione per fotometri di terze parti

$$\text{Conc.} = a + b \cdot \text{Abs} + c \cdot \text{Abs}^2 + d \cdot \text{Abs}^3 + e \cdot \text{Abs}^4 + f \cdot \text{Abs}^5$$

	∅ 24 mm	□ 10 mm
a	$-9.51421 \cdot 10^{-1}$	$-9.51421 \cdot 10^{-1}$
b	$6.99203 \cdot 10^{+1}$	$1.50329 \cdot 10^{+2}$
c	$6.14201 \cdot 10^{+0}$	$2.83914 \cdot 10^{+1}$
d		
e		
f		

## Interferenze

### Interferenze permanenti

1. Le particelle non disciolte possono portare a risultati troppo elevati. Pertanto è importante sciogliere completamente le pastiglie.



Valore pH T

M330

6.5 - 8.4 pH

PH

Rosso fenolo

## Informazioni specifiche dello strumento

Il test può essere eseguito sui seguenti dispositivi. Inoltre, sono indicate la cuvetta richiesta e il range di assorbimento del fotometro.

Dispositivi	Cuvetta	$\lambda$	Campo di misura
MD 100, MD 110, MD 200, MD 600, MD 610, MD 640, MultiDirect, PM 600, PM 620, PM 630	ø 24 mm	560 nm	6.5 - 8.4 pH
XD 7000, XD 7500	ø 24 mm	558 nm	6.5 - 8.4 pH
Scuba II	ø 24 mm	530 nm	6.5 - 8.4 pH

## Materiale

Materiale richiesto (in parte facoltativo):

Reagenti	Unità di imballaggio	N. ordine
Fotometro rosso fenolo	Pastiglia / 100	511770BT
Fotometro rosso fenolo	Pastiglia / 250	511771BT
Fotometro rosso fenolo	Pastiglia / 500	511772BT

## Campo di applicazione

- Acqua di caldaia
- Controllo acqua in vasca
- Trattamento acqua di piscina
- Trattamento acqua non depurata

## Note

1. Per la rilevazione fotometrica del valore di pH si devono utilizzare soltanto pastiglie PHENOL RED con etichetta nera contrassegnate con il termine PHOTOMETER.





## Esecuzione della rilevazione Valore pH con pastiglia

Selezionare il metodo nel dispositivo.

Per questo metodo, non è necessario eseguire una misurazione ZERO ogni volta sui seguenti dispositivi: XD 7000, XD 7500



Riempire una cuvetta da 24 mm con **10 ml di campione**.

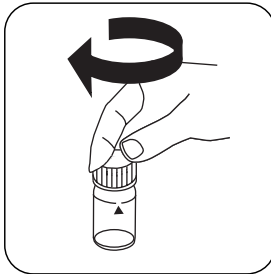

Chiudere la/e cuvetta/e.

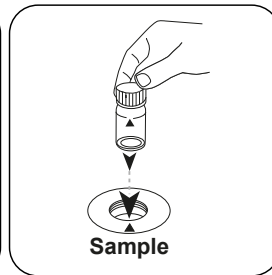

Posizionare la **cuvetta del campione** nel vano di misurazione. Fare attenzione al posizionamento.

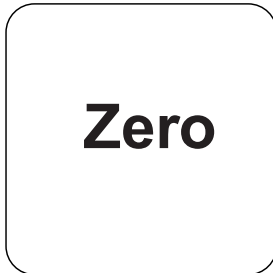

Premere il tasto **ZERO**.

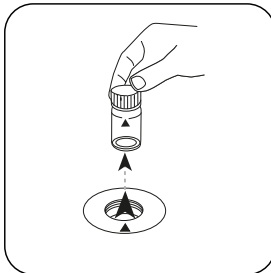

Prelevare la cuvetta dal vano di misurazione.

In caso di dispositivi che **non richiedono una misurazione ZERO, iniziare da qui.**

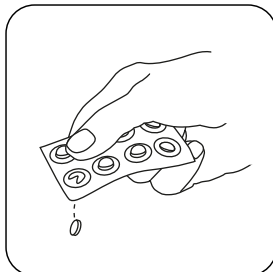

Aggiungere una **pastiglia PHENOL RED PHOTO-METER**.

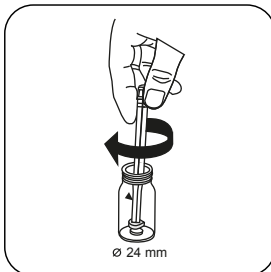

Frantumare la/e pastiglia/e con una leggera rotazione.

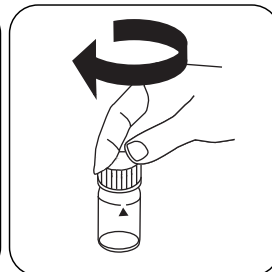

Chiudere la/e cuvetta/e.

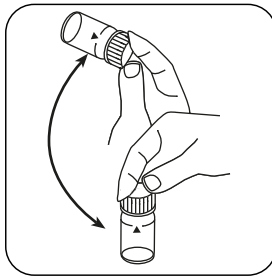

Far sciogliere la/e pastiglia/e agitando.

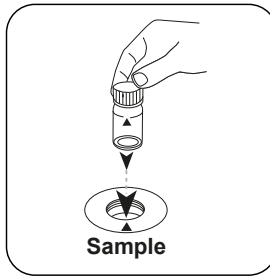

Posizionare la **cuvetta del campione** nel vano di misurazione. Fare attenzione al posizionamento.

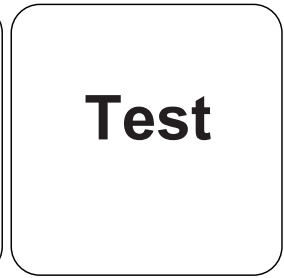

Premere il tasto **TEST** (XD: **START**).

Sul display compare il risultato come valore pH.

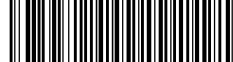

## Metodo chimico

Rosso fenolo

## Appendice

### Funzione di calibrazione per fotometri di terze parti

$$\text{Conc.} = a + b \cdot \text{Abs} + c \cdot \text{Abs}^2 + d \cdot \text{Abs}^3 + e \cdot \text{Abs}^4 + f \cdot \text{Abs}^5$$

	∅ 24 mm	□ 10 mm
a	$5.95215 \cdot 10^{+0}$	$5.95215 \cdot 10^{+0}$
b	$4.13767 \cdot 10^{+0}$	$8.89599 \cdot 10^{+0}$
c	$-5.29861 \cdot 10^{+0}$	$-2.44928 \cdot 10^{+1}$
d	$3.74419 \cdot 10^{+0}$	$3.72112 \cdot 10^{+1}$
e	$-1.25321 \cdot 10^{+0}$	$-2.6778 \cdot 10^{+1}$
f	$1.6149 \cdot 10^{-1}$	$7.41887 \cdot 10^{+0}$

## Interferenze

### Interferenze permanenti

1. I campioni di acqua con una bassa durezza carbonatica\* possono far ottenere valori di pH errati.

$$*K_{\text{S4,3}} < 0,7 \text{ mmol/l} \triangleq \text{alcalinità totale} < 35 \text{ mg/L CaCO}_3.$$

### Interferenze escludibili

1. I valori di pH minori di 6,5 e maggiori di 8,4 possono dare risultati entro il range di misura. Si consiglia un test di plausibilità (misuratore di pH).

2. Errore salino:

Con una salinità fino a 2 g/L non è previsto alcun errore salino significativo dovuto alla salinità della pastiglia di reagente. Con salinità maggiori è necessario correggere i valori di misura nel modo seguente:

Salinità del campione in g/L	30 (acqua di mare)	60	120	180
Correzione	-0,15 <sup>1)</sup>	-0,21 <sup>2)</sup>	-0,26 <sup>2)</sup>	-0,29 <sup>2)</sup>

<sup>1)</sup> secondo Kolthoff (1922)

<sup>2)</sup> secondo Parson e Douglas (1926)

### Riferimenti bibliografici

Colorimetric Chemical Analytical Methods, 9th Edition, London



Alcalinità M T

M30

5 - 200 mg/L CaCO<sub>3</sub>

tA

Acido/indicatore

## Informazioni specifiche dello strumento

Il test può essere eseguito sui seguenti dispositivi. Inoltre, sono indicate la cuvetta richiesta e il range di assorbimento del fotometro.

Dispositivi	Cuvetta	$\lambda$	Campo di misura
MD 100, MD 110, MD 200, MD 600, MD 610, MD 640, MultiDirect, PM 600, PM 620, PM 630	ø 24 mm	610 nm	5 - 200 mg/L CaCO <sub>3</sub>
Scuba II	ø 24 mm		0 - 300 mg/L CaCO <sub>3</sub>
XD 7000, XD 7500	ø 24 mm	615 nm	5 - 200 mg/L CaCO <sub>3</sub>

## Materiale

Materiale richiesto (in parte facoltativo):

Reagenti	Unità di imballaggio	N. ordine
Alka-M-Photometer	Pastiglia / 100	513210BT
Alka-M-Photometer	Pastiglia / 250	513211BT

## Campo di applicazione

- Trattamento acqua potabile
- Trattamento acqua di scarico
- Trattamento acqua non depurata
- Trattamento acqua di piscina
- Controllo acqua in vasca

## Note

1. I termini alcalinità M, valore M, alcalinità totale e capacità acida  $K_{s4,3}$  sono equivalenti.
2. Per l'accuratezza del risultato dell'analisi è fondamentale che il volume del campione misuri esattamente 10 ml.







## Esecuzione della rilevazione Alcalinità, totale = alcalinità M = valore M con pastiglia

Selezionare il metodo nel dispositivo.

Per questo metodo, non è necessario eseguire una misurazione ZERO ogni volta sui seguenti dispositivi: XD 7000, XD 7500



Riempire una cuvetta da 24 mm con **10 ml di campione**.

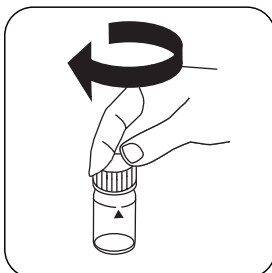

Chiudere la/e cuvetta/e.

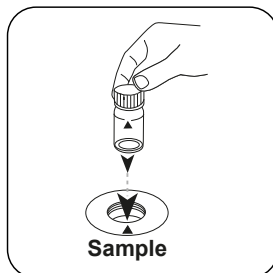

Posizionare la **cuvetta del campione** nel vano di misurazione. Fare attenzione al posizionamento.

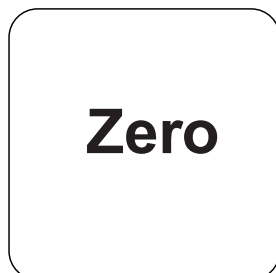

Premere il tasto **ZERO**.

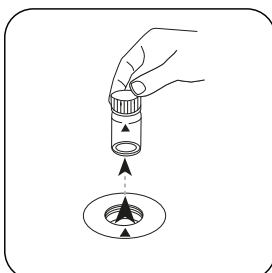

Prelevare la cuvetta dal vano di misurazione.

In caso di dispositivi che **non richiedono una misurazione ZERO, iniziare da qui.**

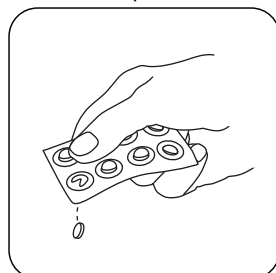

Aggiungere una **pastiglia ALKA-M-PHOTOMETER**.

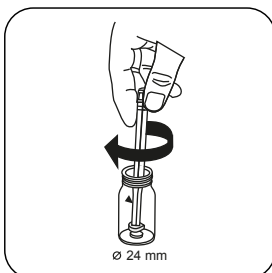

Frantumare la/e pastiglia/e con una leggera rotazione.

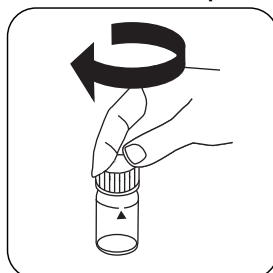

Chiudere la/e cuvetta/e.

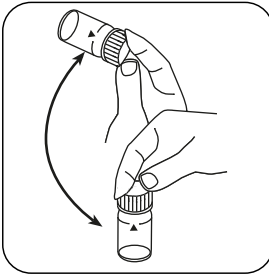

Far sciogliere la/e pastiglia/e agitando.

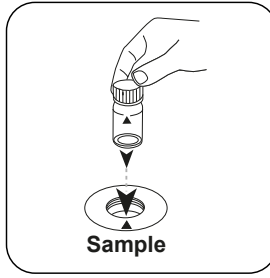

Posizionare la **cuvetta del campione** nel vano di misurazione. Fare attenzione al posizionamento.

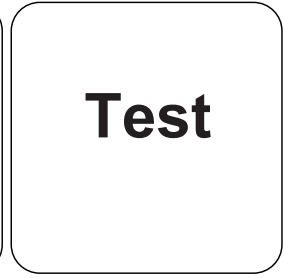

Premere il tasto **TEST** (XD: **START**).

Sul display compare il risultato come alcalinità-m.

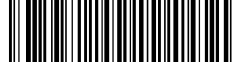

## Valutazione

La seguente tabella identifica i valori di output che possono essere convertiti in altre forme di citazione.

Unità di misura	Forma di citazione	Fattore di conversione
mg/l	CaCO <sub>3</sub>	1
	°dH	0.056
	°eH	0.07
	°fH	0.1
	°aH	0.058
	K <sub>S4.3</sub>	0.02

## Metodo chimico

Acido/indicatore

## Appendice

### Funzione di calibrazione per fotometri di terze parti

Conc. = a + b•Abs + c•Abs<sup>2</sup> + d•Abs<sup>3</sup> + e•Abs<sup>4</sup> + f•Abs<sup>5</sup>

	∅ 24 mm	□ 10 mm
a	-2.46587 • 10 <sup>-1</sup>	-2.46587 • 10 <sup>-1</sup>
b	2.67915 • 10 <sup>+2</sup>	5.76017 • 10 <sup>+2</sup>
c	-1.48158 • 10 <sup>+2</sup>	-6.84858 • 10 <sup>+2</sup>
d	5.11097 • 10 <sup>+1</sup>	5.07947 • 10 <sup>+2</sup>
e		
f		

Derivato di

EN ISO 9963-1